

**KHF** Attachment

助縫設備

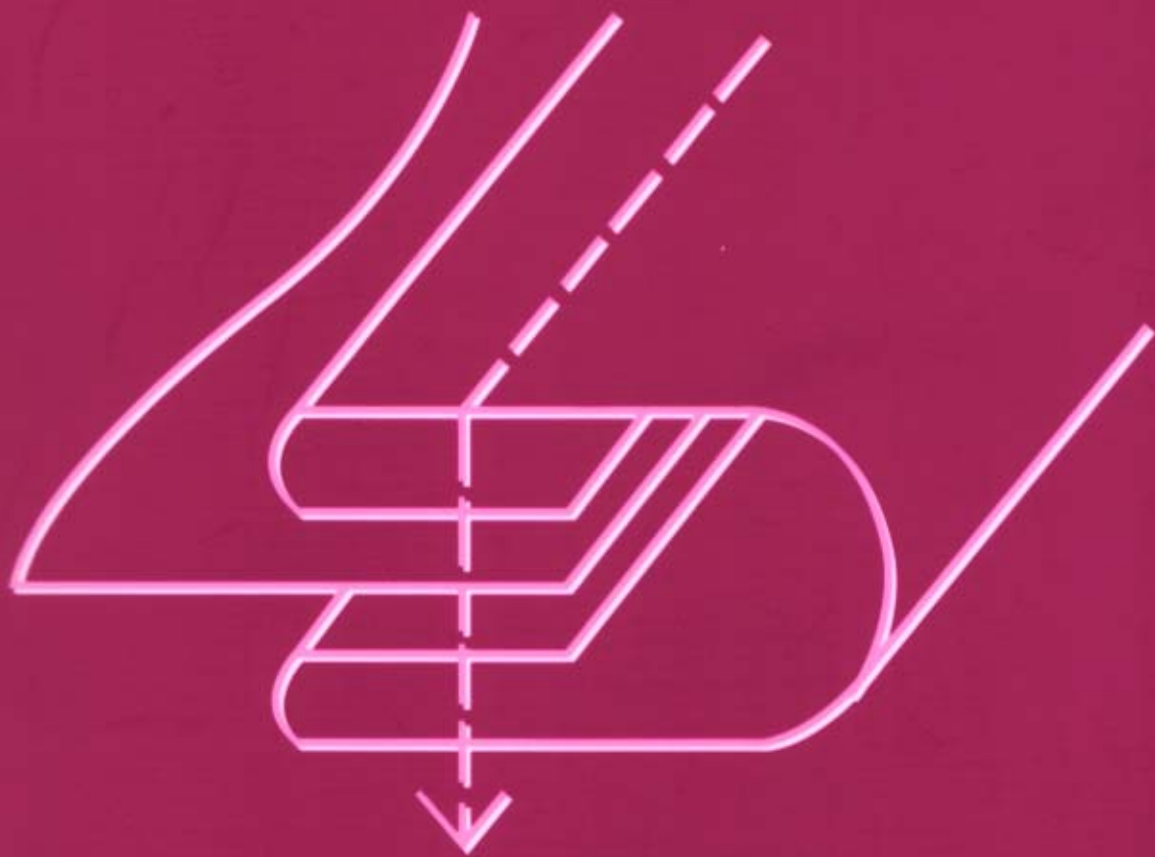

[www.kwokking.com](http://www.kwokking.com)

**K**

2004

## 內容 CONTENT

頁數 Page	產品號碼 Part Number	頁數 Page	產品號碼 Part Number
1	KHF1	42	KHF81, KHF82
2	KHF2, KHF3, KHF4	43	KHF83, KHF84
3	KHF5, KHF6, KHF7	44	KHF85, KHF86
4	KHF8, KHF9, KHF10	45	KHF87, KHF88
5	KHF11, KHF11CU	46	KHF89, KHF90
6	KHF12, KHF13	47	KHF91, KHF92
7	KHF14, KHF15	48	KHF93, KHF94
8	KHF16, KHF17	49	KHF95
9	KHF18, KHF19	50	KHF96, KHF97
10	KHF20S, KHF20D, KHF21	51	KHF98, KHF99
11	KHF22, KHF23	52	KHF100, KHF101
12	KHF24, KHF25	53	KHF102, KHF107
13	KHF26, KHF27, KHF28	54	KHF711
14	KHF29, KHF30, KHF31	55	KHF1412PTV
15	KHF32, KHF33	56	KHF747, KH341T, KHY350T
16	KHF34, KHF35	57	A10, K10, TR-15
17	KHF36, KHF37	58	LP3, LP4, AT-18
18	KHF38, KHF39	59	KHF111, KHF112, KHF122, KHF162, KHF528, KHF622, KG52-747, KHF32-PN/PW
19	KHF40, KHF41	60	23420, 23564, 63920
20	KHF42, KHF43	61	107-029, 107-029K, 23770, 23770K
21	KHF44, KHF45	62	210562A-3, 210562A-4, 210562A-5, 210516A-3, 210516A-4, 210516A-5, 210596A-3, 210596A-4, 210596A-5
22	KHF46, KHF47	63	457-CL, 210562A-2, 210569-A, 210569-B, 212-005A
23	KHF48, KHF49	64	212-112, 212-684, 23061
24	KHF50, KHF51	65	23071, 23072, 23073
25	KHF52, KHF53	66	23207, 24711, 21140
26	KHF54, KHF55	67	21139A, 21139B, 21139C, K41B
27	KHF56, KHF57	68	2N Gauge Set, PR112, PL112, PD112, PH112W, 112WC9, 112W-Z, 112W952
28	KHF57	69	21010, K22060S, K224060M, 23067, 44227, 42819, MAQ980A0, MAQ10452000, 17086, 17083, S512S, S513S, U192B, U193B
29	KHF58	70	NP-3, NP-4, NP-5, NP-6, FD-3, FD-4, FD-5, FD-6, KH5-NP, KH5-FD, KH7-NP, KH7-FD
30	KHF59, KHF60	71	KR-10, A10, K10, KB, 131S, KR-1, KL-1, KL-11, KL-12
31	KHF61, KHF62	72	CKL-13, P36xx, P38xx, SP-19, SP-705, SP-733, SP-98, SP-102
32	KHF62	73	160344H, 120803H, 120805H, 120806H, 490357, 490358, 490359, 490360, P69R, P69L, P69D
33	KHF63, KHF64	74	1404P, 1404PSF, 1404PL Gauge Set
34	KHF65, KHF66	75	1406P, 1406PL, 1412P, 1412PL, 1508P Gauge Set, KP40MG
35	KHF67, KHF68	76	17-7620-1, KH577, D530, 112607SP, 240144B, 240112HB, 524-206-AL, 524-206-3
36	KHF69, KHF70	77	TS-1, TS-2, TS-3, ES-1, ES-2
37	KHF71, KHF72	78	KTR-3, KTR-4, KTR-5, KTR-6
38	KHF73, KHF74	79	KHM-803, KHM-803A, KHM-804, KHM-804A
39	KHF75, KHF76		
40	KHF77, KHF78		
41	KHF79, KHF80		

# KHF 1

## 懸掛式雙針貼帶器

### Suspended Tape Folder (Double Needle)

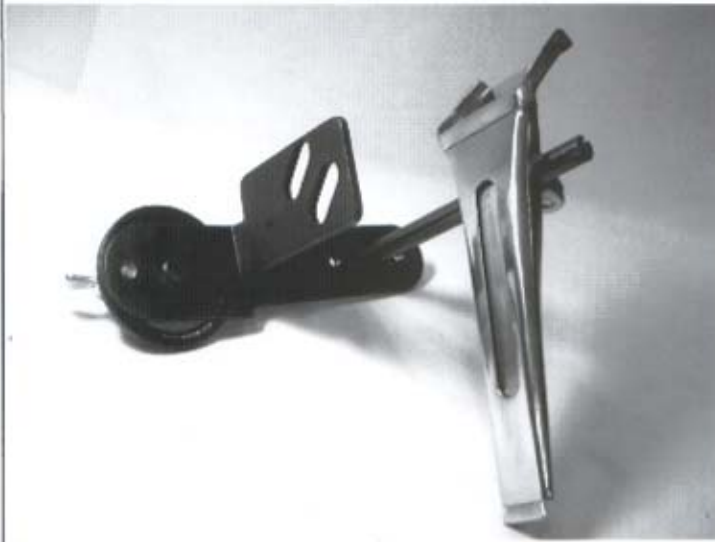

KHF1 不包括支架

KHF1 do not include the bracket.

可用配件 Applicable Parts:

1. 壓腳 Presser Feet: PD112x1 & PD112x1.8
2. 支架 Folder Bracket: KHF122

入口寬度 Tape Size	出口寬度 Finished Size
1"	1/2"
1-1/4"	5/8"
1-1/2"	3/4"
1-3/4"	7/8"
2"	1"
2-1/4"	1-1/8"
2-1/4"	1-1/4"
2-3/8"	1-3/8"
2-1/2"	1-1/2"



## 細筒筒型車包邊器

### Binder for Small-sized Cylinder Bed Machine

薄物·皮革及塑膠材料用 For Thin Leather and Plastic Material

所包縫物料厚度 Thickness of Material Binded 5mm & 7mm

#### KHF 2 (散口 Raw Edge)

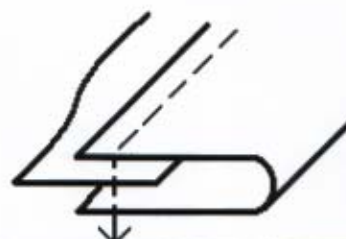

入口寬度 Tape Size	
10mm	18mm
12mm	20mm
13mm	22mm
14mm	24mm
16mm	26mm

#### KHF 3 (面環底散 Single Fold)

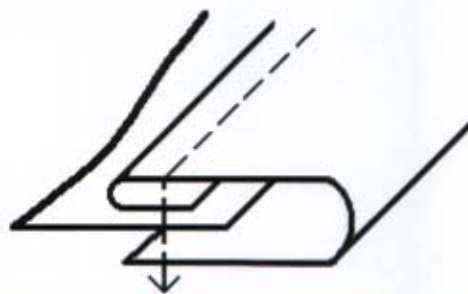

入口寬度 Tape Size	
18mm	24mm
20mm	26mm
22mm	28mm

#### KHF 4 (雙環 Double Fold)

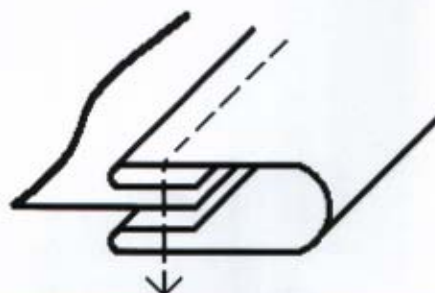

入口寬度 Tape Size	
18mm	26mm
20mm	28mm
22mm	30mm
24mm	32mm

## 平車皮革包邊器

### Edge Binder for Single Needle Machine

薄物·皮革及塑膠材料用 For Thin Leather and Plastic Material

#### KHF 5 (散口 Raw Edge)

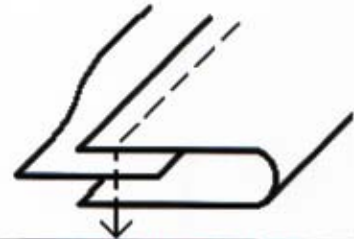

入口寬度 Tape Size	
8mm	16mm
10mm	18mm
12mm	20mm
14mm	22mm

#### KHF 6 (面環底散 Single Fold)

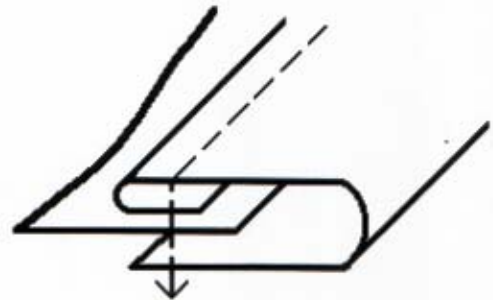

入口寬度 Tape Size	
12mm	12mm
14mm	14mm
16mm	16mm
18mm	18mm

#### KHF 7 (雙環 Double Fold)

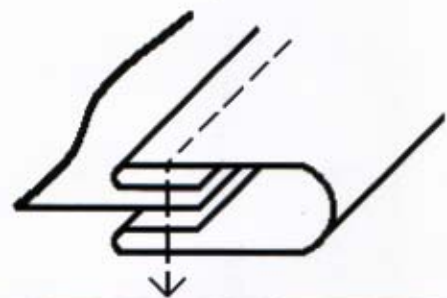

入口寬度 Tape Size	
18mm	18mm
20mm	20mm
22mm	22mm
24mm	24mm



# KHF 8

## 大筒筒型車包邊器

### Binder for Large-sized Cylinder-bed Machine

薄物·皮革及塑膠材料用 For Thin Leather and Plastic Material

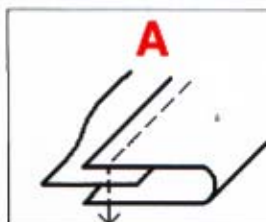
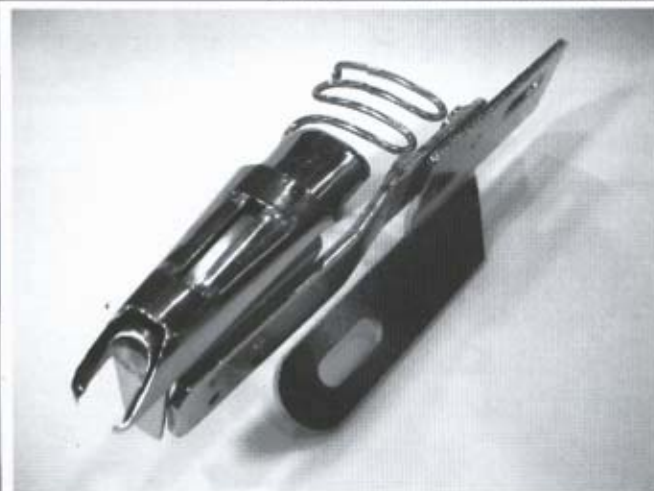

入口寬度 Tape Size

5/8"

3/4"

7/8"

1"

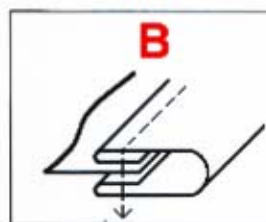

入口~出口  
Tape~Finished Size

1" ~ 1/4"

1-1/4" ~ 5/16"

1-1/4" ~ 3/8"

# KHF 9

## 擺動式卷邊器

### Swing Hemmer

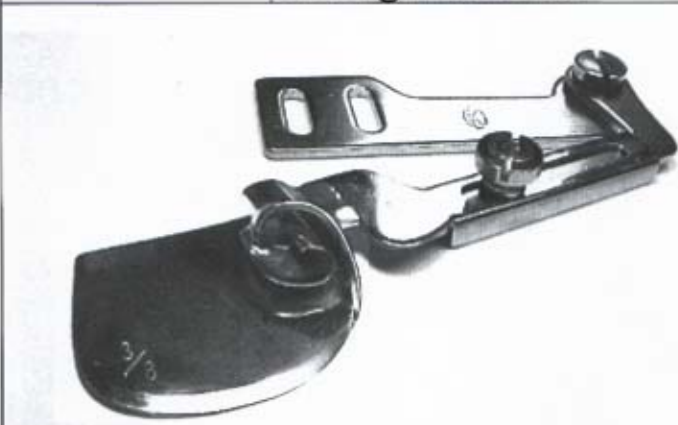

出口寬度 Finished Size

1/16"

5/16"

1/8"

3/8"

3/16"

7/16"

1/4"

1/2"

可用配件 Applicable Parts: KL-13, SP-733

# KHF 10

## 平車直角包邊器

### Right Angle Bias Binder



入口寬度 Tape Size

16mm	22mm	28mm	34mm	40mm	50mm
18mm	24mm	30mm	36mm	42mm	
20mm	26mm	32mm	38mm	45mm	

**KHF 11**

褲子腰部上下兩層包縫器

Two Pieces Waist Band Folder

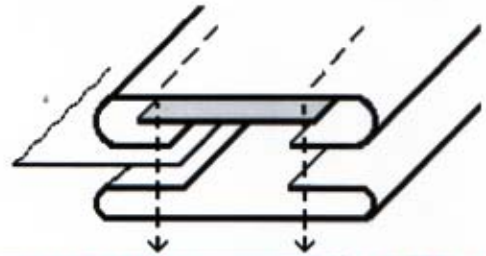

入口 Tape Size	出口 Finished Size
2"	1"
2-1/8"	1-1/8"
2-1/4"	1-1/4"
2-3/8"	1-3/8"
2-1/2"	1-1/2"
2-5/8"	1-5/8"
2-3/4"	1-3/4"
2-7/8"	1-7/8"

可用配件 Applicable Parts:

1. 關西多針車針位 Multi-needle Gauge Set for Kansai Special
2. 112WC-9
3. KP404G

**KHF 11CU**

褲子腰部上下兩層彎形包縫器

Two Pieces Curve Waist Band Folder

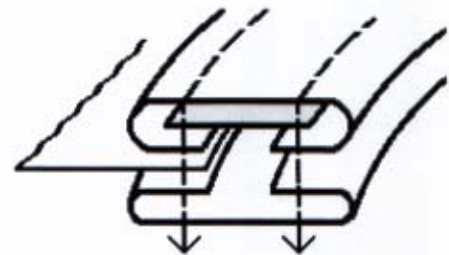

入口 Tape Size ~ 出口 Finished Size  
2-1/2" ~ 1-1/2"

可用配件 Applicable Parts:

1. 關西多針車針位 Multi-needle GaugeSet for Kansai Special
2. 112WC-9

**KHF 12** 散口包邊器  
 Braid or Tape Binder

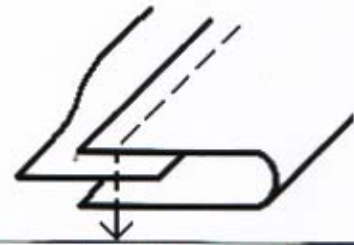

入口寬度 Tape Size	
1/2"	1"
5/8"	1-1/8"
3/4"	1-1/4"
7/8"	1-1/2"

**KHF 13** 管條包縫器  
 Piping Folder

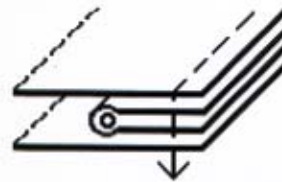

入口寬度 Tape Size		
1/2"	7/8"	1-1/4"
5/8"	1"	1-3/8"
3/4"	1-1/8"	1-1/2"

可用配件 Applicable Parts:

1. P69LH
2. SP-70L



**KHF 14**

褲子腰部鬆緊帶捲邊器(繃縫車用)

Down Turn Elastic Hemmer for Covering Stitch

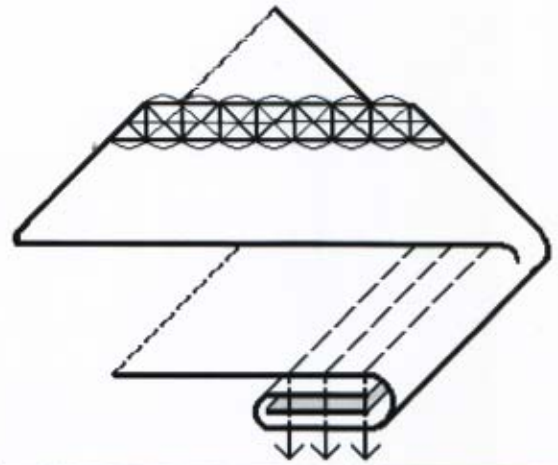

出口寬度 Finished Size

1/4"	3/8"	1/2"
------	------	------

**KHF 15**

散口摺邊器(繃縫車用)

Single Up-turn Folder for Covering Stitch

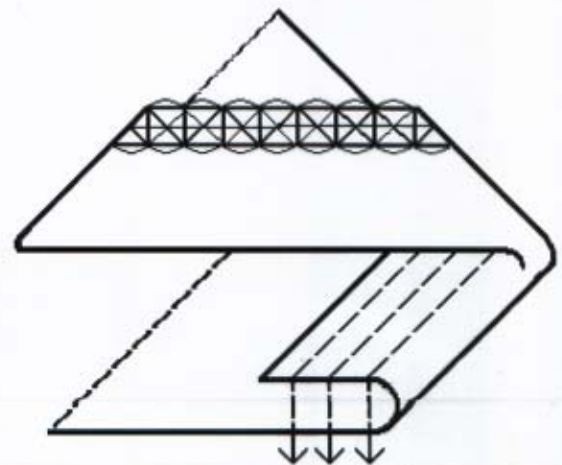

出口寬度 Finished Size

1/8"	3/16"	1/4"
------	-------	------

**KHF 16** 雙針接袖器  
Double Needle Sleeve Attachment



針距 Needle Space

3/16"

1/4"

可用配件 Applicable Parts:

1. PL112x1 & PL112x1.8  
壓腳 Presser Feet

**KHF 17** 擺動式散口摺邊器  
Single Upturn Folder

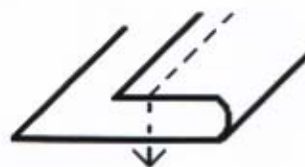

出口寬度 Finished Size

1/8"	7/16"	1"
3/16"	1/2"	1-1/8"
1/4"	5/8"	1-1/4"
5/16"	3/4"	1-1/2"
3/8"	7/8"	

可用配件 Applicable Parts:

1. 平車高低針板牙  
Special Needle Plate & Feed Dog for Folders
2. KR-1 & KL-1 壓腳 Presser Feet
3. KH7 針板, 牙 Needle Plate, Feed Dog

**KHF 18**

平車鞋邊包縫器

Single Needle Binders (for Shoes)

厚物·皮革及塑膠材料用 For Thick Leather and Plastic Material

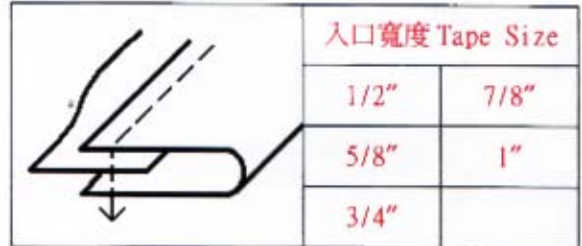

可用配件 Applicable Parts:

1. A10 壓腳 Presser Feet
2. KR-10 壓腳 Presser Feet
3. K10 壓腳 Presser Feet
4. KB Presser Feet

**KHF 19**

單針接袖器 (雙針車部份)

Single Needle Sleeve Attachment

(Double Needle Machine Operation)

出口寬度 Finished Size : 3/8"

針距 Needle Space : 1/4"



1<sup>st</sup> step 雙針車縫合  
Double Needle Machine Operation

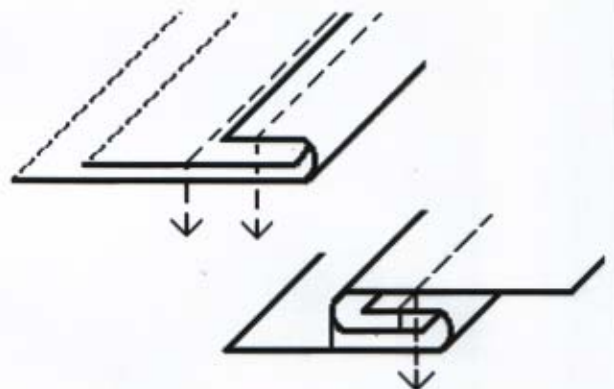

2<sup>nd</sup> step 熨摺再用單針縫合  
Single Needle Operation,  
after Hand-folded and Ironed

可用配件 Applicable Parts:

1. PL112x1 & PL112x1.8 壓腳 Presser Feet



## KHF 20S

### 單針背肩助縫器(擔杆)

### Single Needle Back Yoke Attachment

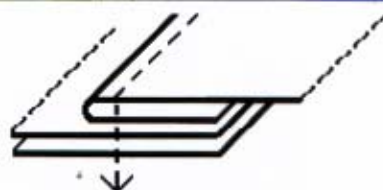

出口寬度 Finished Size : 3/8"

可用配件 Applicable Parts:

1. 平車高低針板牙 Special Needle Plate & Feed Dog for Folders
2. KL-1
3. SP-705

## KHF 20D

### 雙針背肩助縫器(擔杆)

### Double Needle Back Yoke Attachment

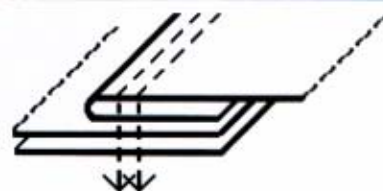

出口寬度 Finished Size : 3/8"

可用配件 Applicable Parts:

1. 平車高低針板牙 Special Needle Plate & Feed Dog for Folders
2. KL-1
3. SP-705

## KHF 21

### 雙針袋口捲邊器

### Upturn Pocket Hemmer for Double Needle

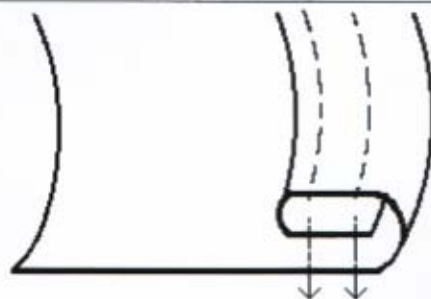

出口寬度 Finished Size

3/16"	5/16"	1/2"
1/4"	3/8"	

可用配件 Applicable Parts:

1. PL112x1 & PL112x1.8

**KHF 22**

可調教式摺邊器(繙縫車用)

Adjustable Single Down-turn Folder (for Covering Stitch)

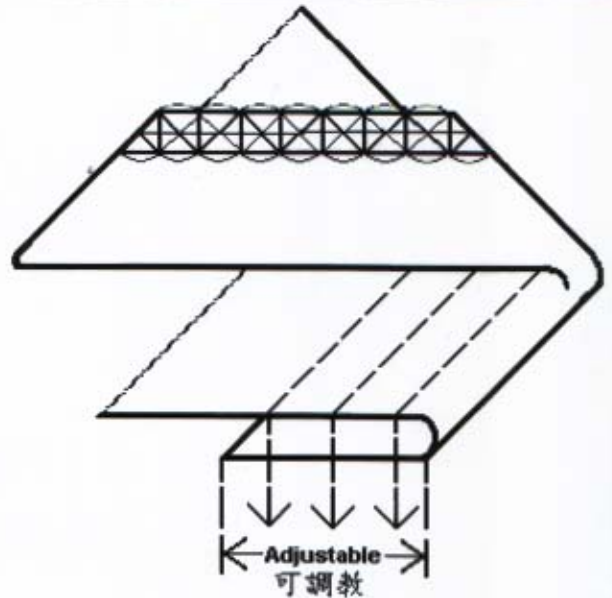

**KHF 23**

袖口接縫器 (雞英)

Cuff Setter

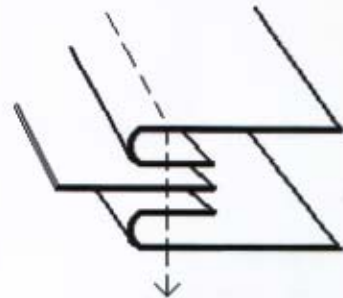

可用配件 Applicable Parts:

1. KL-1
2. KH7
3. 平車高低針板牙 Special Needle Plate & Feed Dog for Folders

**KHF 24** 擺動式捲邊器  
**Swing Hemmer**



出口寬度 Finished Size

9/16"	1-1/8"	1-3/4"
5/8"	1-1/4"	1-7/8"
3/4"	1-3/8"	2"
7/8"	1-1/2"	
1"	1-5/8"	

可用配件 Applicable Parts:

1. KL-13
2. CKL-13
3. KH7
4. 平車高低針板牙 Special Needle Plate & Feed Dog for Folders

**KHF 25** 衣袖接縫器  
**Lap Seam Folder**

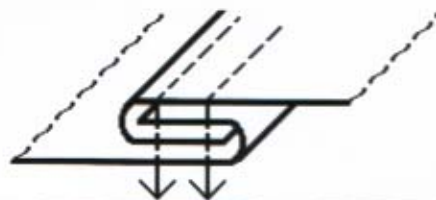

針距 Needle Space

3/16"	1/4"
5/16"	3/8"



## 大筒筒型車懸掛式包邊器

### Suspended Binder for Large-sized Cylinder Bed Machine

薄物·皮革及塑膠材料用 For Thin Leather and Plastic Material

#### KHF 26 (散口 Raw Edge)

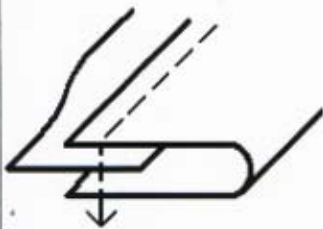

入口寬度 Tape Size	
5/8"	1"
3/4"	1-1/4"
7/8"	1-1/2"



#### KHF 27 (環口 Double Fold)

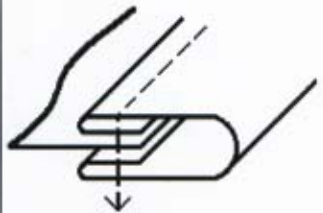

入口 ~ 出口 Tape ~ Finished Size	
1" ~ 1/4"	
1-1/4" ~ 5/16"	
1-1/2" ~ 3/8"	

可用配件 Applicable Parts:

- 筒型車包邊壓腳 Cylinder-bed Machine Presser Foot for Binder

#### KHF 28

#### 雙針面貼網條壓腳

#### Double Needle Tape Attaching Foot

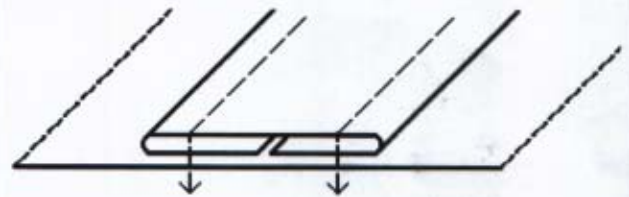

針距 Needle Space	出口寬度 Finished Size
1/8"	1/4"
3/16"	5/16"
1/4"	3/8"
5/16"	7/16"
3/8"	1/2"
1/2"	5/8"

**KHF 29** 平車帶狀摺縫壓腳  
Loop Folder Foot

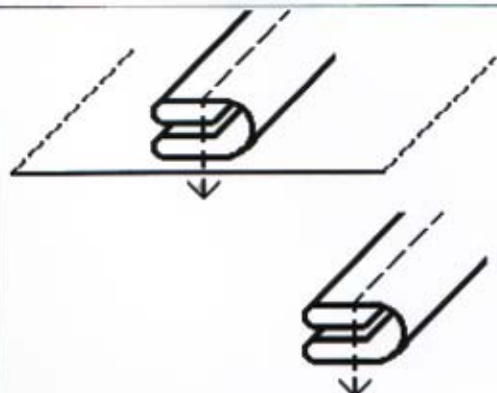

出口寬度 Finished Size		
1/8"	3/16"	1/4"

袖叉包縫器  
Sleeve Placket Binder

**KHF 30**

Finished Size 出口寬度			
1/4"	3/8"	5/8"	7/8"
5/16"	1/2"	3/4"	1"

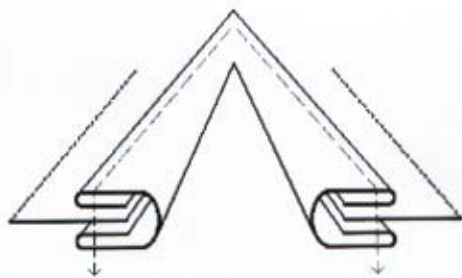

**KHF 31** (內藏襯裡 with Lining)

Finished Size 出口寬度		
1"	1-3/8"	1-3/4"
1-1/8"	1-1/2"	1-7/8"
1-1/4"	1-5/8"	2"

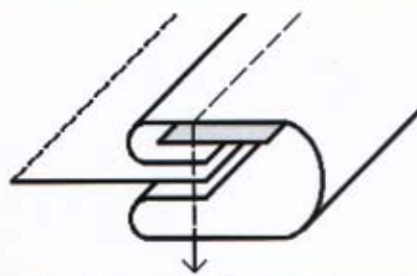

可用配件 Applicable Parts:

1. KL-13
2. CKL-13
3. KH7
4. 平車高低針板牙 Special Needle Plate & Feed Dog for Folder



**KHF 32** 邊縫搭接捲邊器 (日字埋夾)  
Side Seam Lapper (Japanese Style)

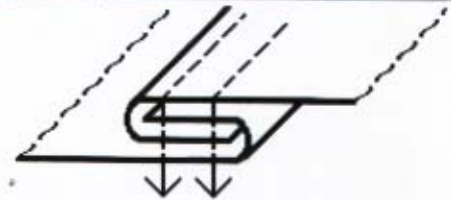

針距 Needle Space	
1/8"	1/4"
3/16"	5/16"

厚度 Thickness			
M	MH	H	XH

可用配件 Applicable Parts:

1. 闊/窄導向板  
Narrow or Wide Lapper Guide Plate

**KHF 33** 褲子腰部包縫器  
Waist Band Folder

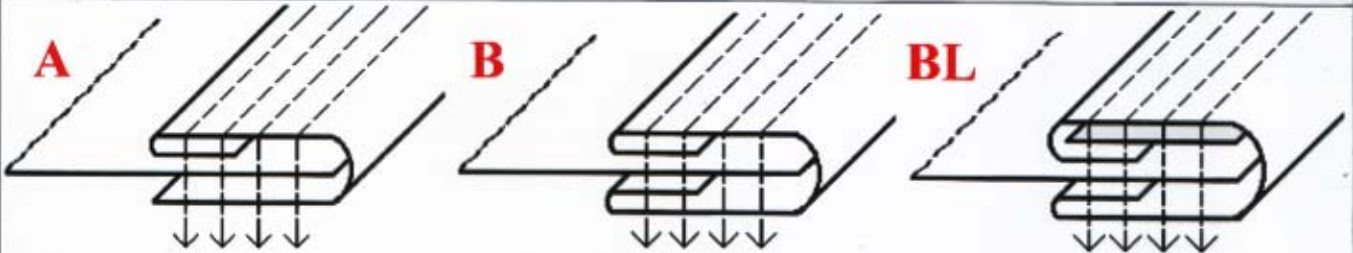

入口 Tape Size	出口 Finished Size
2-3/4"	1"
3"	1-1/8"
3-1/4"	1-1/4"
3-1/2"	1-3/8"
3-3/4"	1-1/2"
4"	1-5/8"
4-1/4"	1-3/4"
4-1/2"	1-7/8"
4-3/4"	2"
5/1-4"	2-1/4"
5-3/4"	2-1/2"
4"	1-1/2"

可用配件 Applicable Parts:

1. 關西多針車針位  
Multi-needle Gauge Set for Kansai Special



# KHF 34

## 繙縫車摺邊器

### Single Down Turn Folder for Covering Stitch

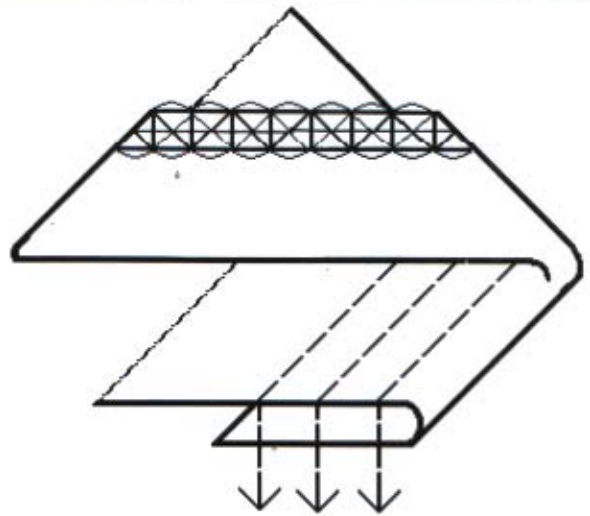

出口寬度 Finished Size			
3/8"	5/8"	1"	1-1/2"
1/2"	3/4"	1-1/4"	

# KHF 35

## 襯衫假前胸捲邊器

### Imitation Folder

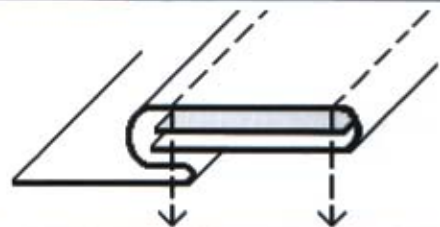
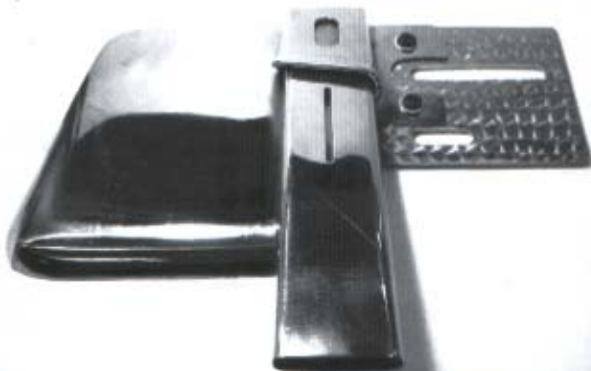

出口寬度 Finished Size		
1"	1-1/8"	1-3/6"
1-1/4"	1-3/8"	1-1/2"

可用配件 Applicable Parts:

1. 雙針針位 Double Needle Gauge Set
2. 關西多針車針位 Multi-needle Gauge Set for Kansai Special
3. 112WC-9
4. PD112x1, PD112x1.8
5. KP404G

# KHF 36

## 人字縫包邊器 Edge Binder (for Zigzag Sewing)

薄物, 皮革及塑膠材料用 For Thin Leather and Rubber Material



可用配件 Applicable parts:

- 1, 210562A, 210516A, 210596A 壓腳、針板、牙 Presser Foot, Needle Plate, Feed Dog
- 2, 112607SP 推板 Slide Plate
- 3, 23067 針位 Gauge Set



# KHF 37

## 雙針後袋口摺邊器 Double Needle Downturn Back Pocket Hemmer

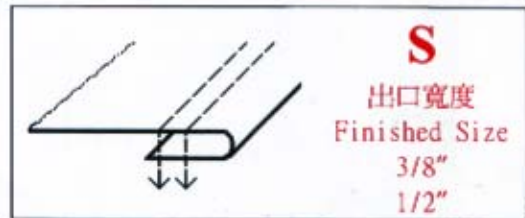

可用配件 Applicable Parts:

- 1. PL112x1 & PL112x1.8

**KHF 38** 袖圈貼邊器  
Sleeve Facing Folder

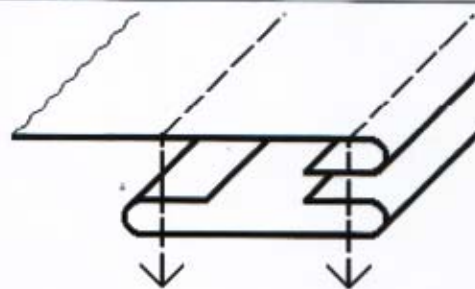

出口寬度 Finished Size : 3/8"

針距 Needle Space : 1/4"

可用配件 Applicable Parts:  
1. PR112x1 & PR112x1.8

**KHF 39** 單針肩部接縫器 (納膊)  
Single Needle Shoulder Top Stitch Attachment

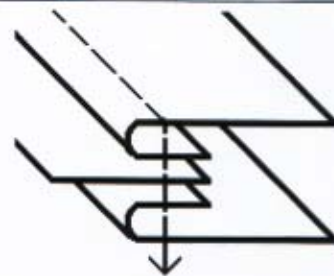

入口寬度 Tape Size : 3/8"

可用配件 Applicable Parts:  
1. 平車高低針板牙 Special Needle Plate & Feed Dog for Folders  
2. KL-1  
3. SP-705



**KHF 40** 綑縫車摺邊器  
Single Down-turn Folder for Covering Stitch

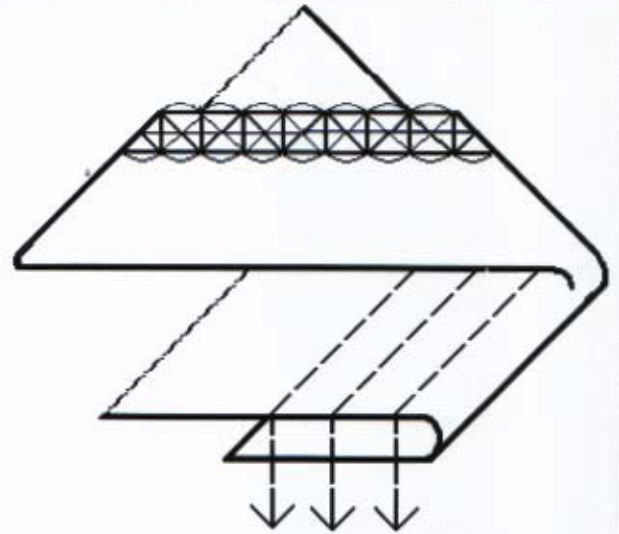

出口寬度 Finished Size			
3/8"	1/2"	5/8"	3/4"
7/8"	1"	1-1/4"	1-1/2"

**KHF 41** 雙針手挽帶拉帶器  
Double Needle Belt Folder

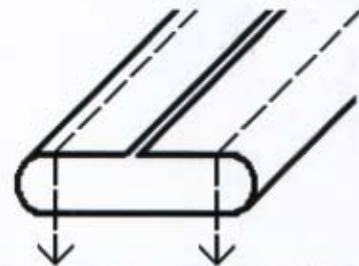

入口 Tape Size	出口 Finished Size
3/8"	3/16"
1/2"	1/4"
5/8"	5/16"
3/4"	3/8"
1"	1/2"
1-1/4"	5/8"
1-1/2"	3/4"
1-3/4"	7/8"
2"	1"
2-1/4"	1-1/8"
2-1/2"	1-1/4"
3"	1-1/2"

可用配件 Applicable Parts:  
1. PD112x1, PD112x1.8

**KHF 42** 襯衫前胸原身捲邊器  
Top Center Plait Hemmer

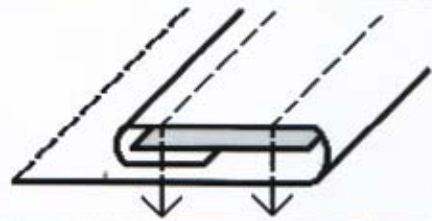

出口寬度 Finished Size			
3/4"	7/8"	1"	1-1/8"
1-1/4"	1-3/8"	1-1/2"	

可用配件 Applicable Parts:

1. PD112
2. 關西多針車針位  
Multi-needle Gauge Set for Kansai Special
3. KP404G

**KHF 43** 褲耳摺縫器  
Belt Loop Folder

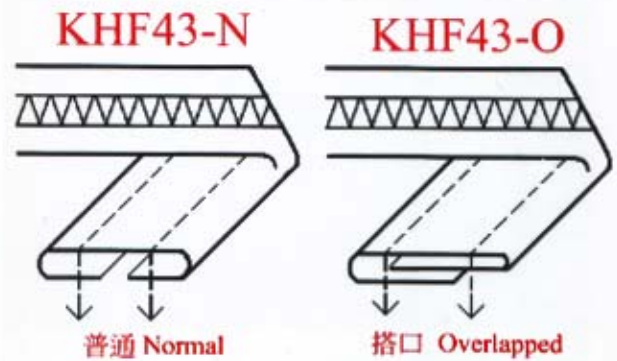

出口寬度 Finished Size			
1/4"	7/16"	3/4"	1-1/8"
5/16"	1/2"	7/8"	1-1/4"
3/8"	5/8"	1"	1-1/2"

可用配件 Applicable Parts:

1. 17-76201
2. KHS77



**KHF 44**

左右兩用拉鍊助縫器

**Both Side Downturn Zipper Attachment**

左右摺邊器皆可以自由拆除 One of both sides can be moved freely.

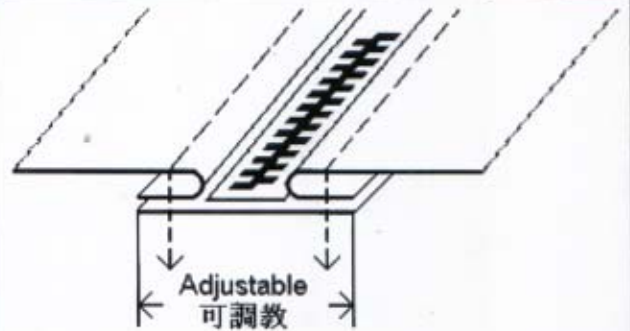

可用配件 Applicable Parts:

1. K224060M
2. 259635
3. PR112x1, PR112x1.8
4. PL112x1, PL112x1.8

**KHF 45**

褲子腰部鬆緊帶貼邊器

**Bottom Elastic Waist Band Folder**

下層鬆緊帶寬度可以自由調教 Bottom Elastic Size is Adjustable.

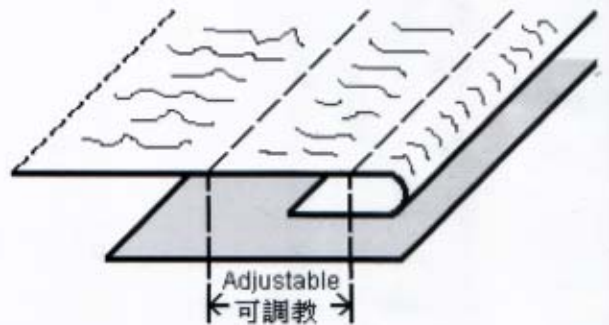

可用配件 Applicable Parts:

1. 關西多針車針位 Multi-needle Gauge Set for Kansai Special



**KHF 46**

摺邊器連 T 字傍位 (繙縫車用)

Downturn Folder for Covering Stitch Machine with T-Guide

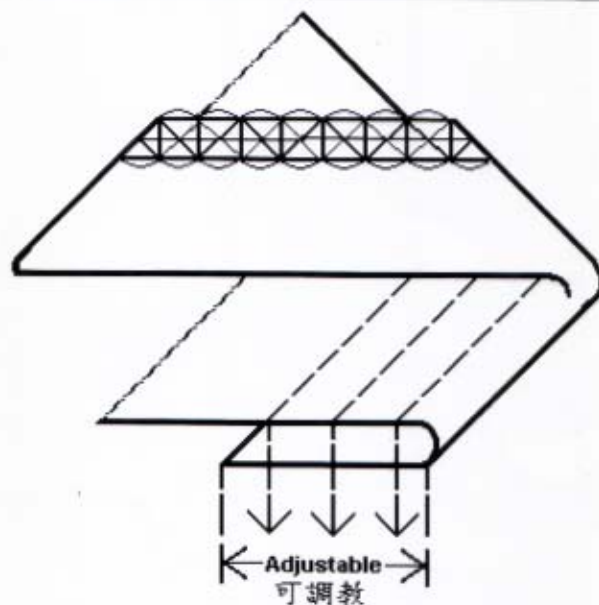
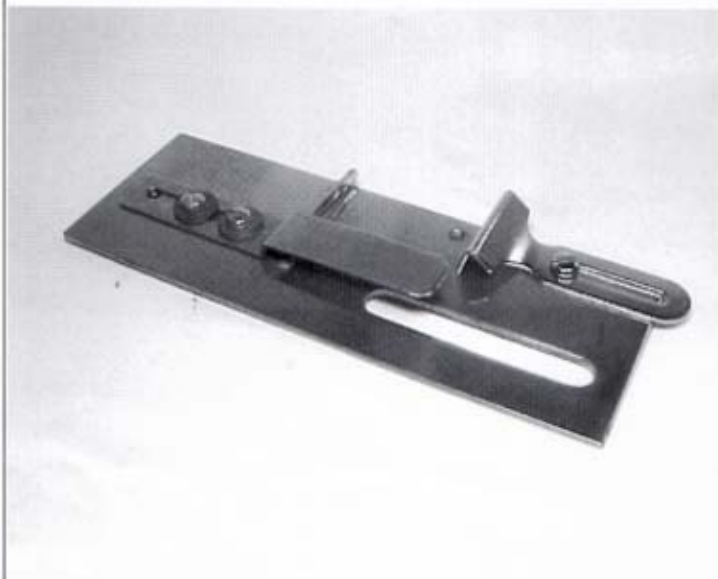

**KHF 47**

可調教式人字縫摺邊器

Adjustable Upturn Hemmer for Zigzag Machine

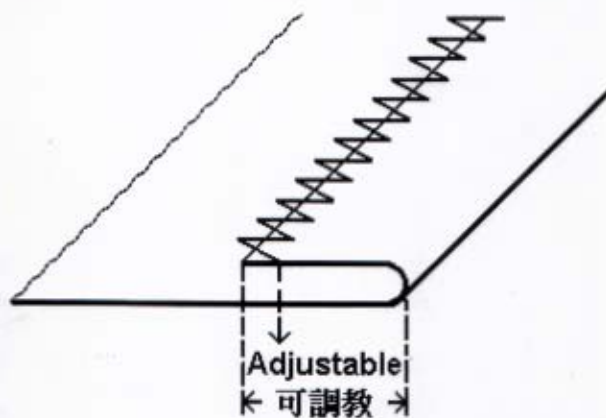

可用配件 Applicable Parts:  
1. 457CL.

# KHF 48

## 大筒筒型車包邊器

### Binder for Large-sized Cylinder Bed Machine

厚物,皮革及塑膠材料用 For Thick Leather and Plastic Material



可用配件 Applicable Parts:

- 筒型車包邊壓腳  
Cylinder-bed Machine Presser Foot for Binder

**B**

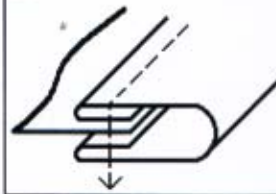

入口寬度 Tape Size

18mm	26mm
20mm	28mm
22mm	30mm
24mm	32mm

**C**

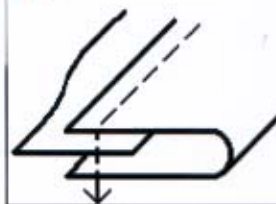

入口寬度 Tape Size

10mm	18mm
12mm	20mm
13mm	22mm
14mm	24mm

# KHF 49

## 環口包邊器

### Double Fold Binder



可用配件 Applicable Parts:

- KL-13

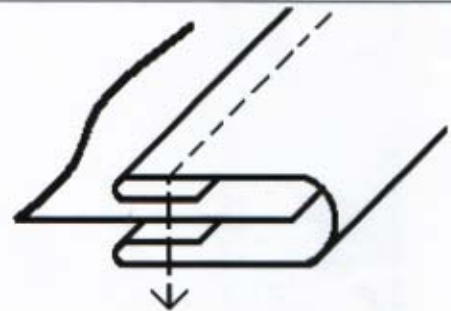

入口 Tape Size	出口 Finished Size
3/4"	3/16"
7/8"	1/4"
1"	1/4"
1-1/8"	5/16"
1-1/4"	5/16"
1"	3/8"
1-1/4"	3/8"
1-1/2"	3/8"
1-1/2"	1/2"
1-3/4"	1/2"

**KHF 50**

通心暗線縫拉帶器  
Spaghetti Attachment

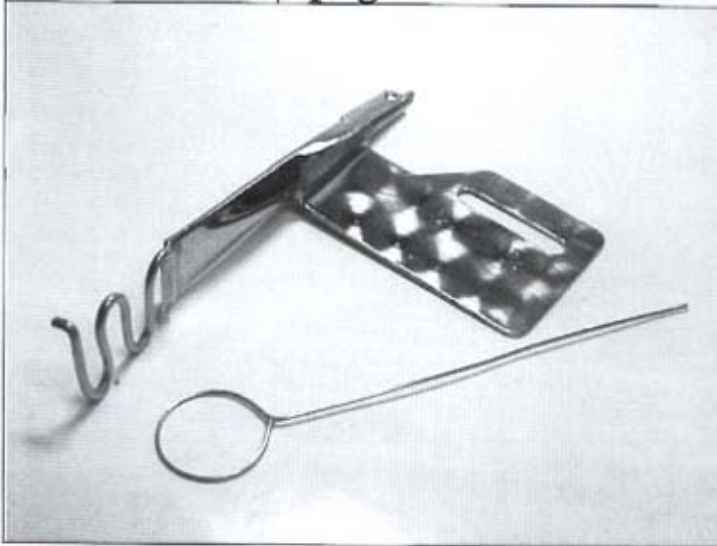

出口寬度 Finished Size		
1/8"	3/16"	1/4"
5/16"	3/8"	1/2"

**KHF 51**

切刀車褲耳拉帶器

Belt Loop Folder for Belt Loop Machine with Cutter

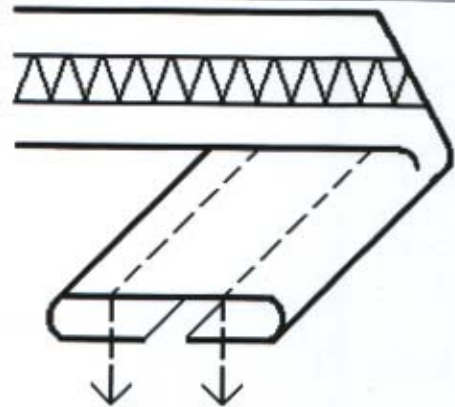

出口寬度 Finished Size				
8mm	9mm	10mm	11mm	12mm
13mm	14mm	15mm	16mm	19mm

可用配件 Applicable Parts:

1. 17-76201 壓腳 Presser Feet
2. KH577 壓腳 Presser Feet



**KHF 52** 雨傘捲邊器  
Twin Plain Hemmer

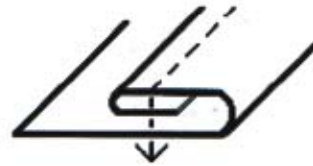

出口寬度 Finished Size

2.5mm & 3mm

3mm & 4mm

**KHF 53** 擺動式彈弓摺邊器  
Spring Type Swing Hemmer



出口寬度 Finished Size

1/8"      1/4"      3/8"

3/16"      5/16"      1/2"

可用配件 Applicable Parts:

**KHF53P** 摺邊壓腳 Hemming Feet

**A70** 送布齒 Feed Dog

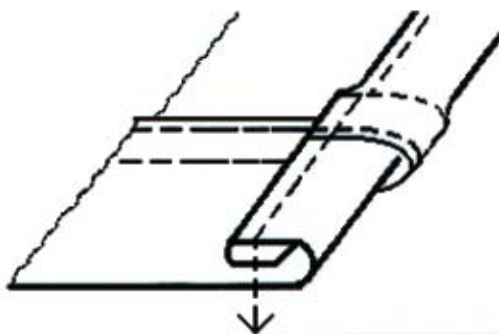

**KHF 54** 擺動式包鬆緊帶捲邊器  
Swing Hemmer with Elastic

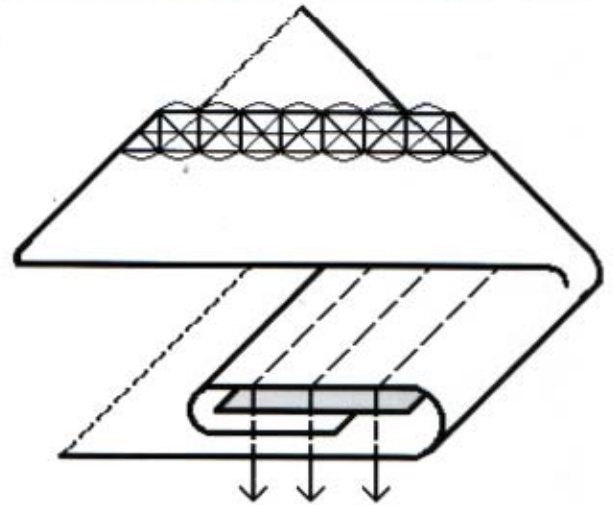

鬆緊帶寬度 Elastic Size

1/4"

3/8"

**KHF 55** 襯衫前胸面貼器  
Top Center Plait Folder

雙針車及關西多針車合用

For Double Needles Machine & Kansai Special Multi-needles Machine

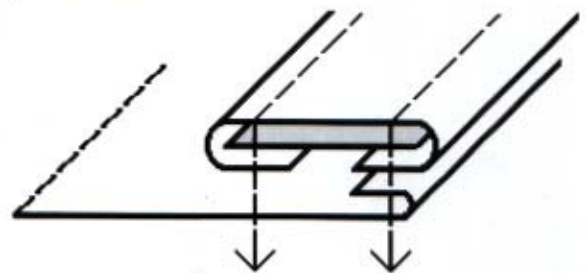

出口寬度 Finished Size

3/4"	7/8"	1"
1-1/8"	1-1/4"	1-3/8"
1-1/2"	1-5/8"	1-3/4"

可用配件 Applicable Parts:

1. 關西多針車針位 Multi-needle Gauge Set for Kansai Special
2. 112WC-9 壓腳 Presser Feet
3. PD112x1, PD112x1.8 壓腳 Presser Feet
4. KP404G 壓腳 Presser Feet



**KHF 56**

雙針衣袖接縫器

Lap Seam Folder for Double Needle Machine

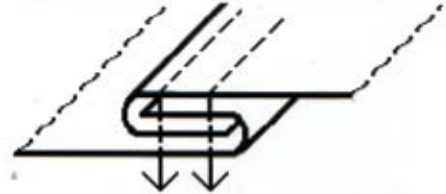

針距尺寸及厚度

Needle Space & Thickness

3/16S	3/16M	3/16H
1/4S	1/4M	1/4H
5/16M	3/8M	3/8H

可用配件 Applicable Parts:

1. PL112x1 & PL112x1.8

**KHF 57**

繙縫車直角包邊器 (坐起式)

Right Angle Binder for Covering Stitch Machine

**A**

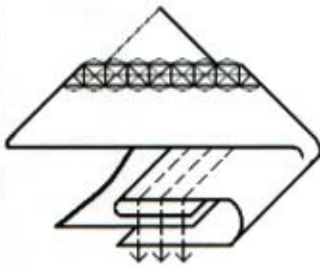

**B**

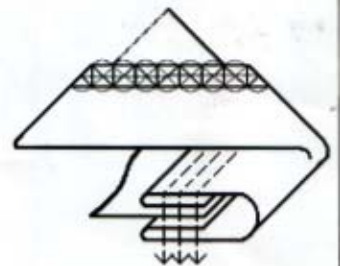

**KHF57A**

( 面環底散 Single Fold )

入口 Tape Size -- 出口 Finished Size

3/4"	1/4"
15/16"	5/16"
1-1/8"	3/8"
1-3/8"	1/2"
1-5/8"	5/8"
1-7/8"	3/4"
2-1/8"	7/8"
2-3/8"	1"
2-5/8"	1-1/8"
2-7/8"	1-1/4"
3-1/8"	1-3/8"
3-3/8"	1-1/2"

**KHF57B**

( 雙環口 Double Fold )

入口 Tape Size -- 出口 Finished Size

1"	1/4"
1-1/4"	5/16"
1-1/2"	3/8"
1-3/4"	1/2"
2"	5/8"
2-1/4"	3/4"
2-1/2"	7/8"
2-3/4"	1"
3"	1-1/8"
3-1/4"	1-1/4"
3-1/2"	1-3/8"
3-3/4"	1-1/2"



**KHF57C**

(散口 Raw Edge)

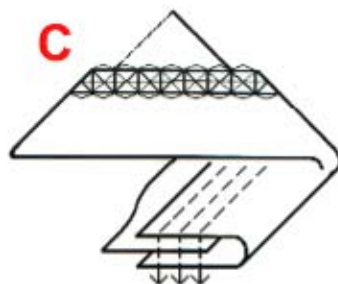

入口 Tape Size	出口 Finished Size
1/2"	1/4"
5/8"	5/16"
3/4"	3/8"
7/8"	7/16"
1"	1/2"



**C2**

**KHF57C2** 有特殊的鬆緊控制器，將夾子開關及鬆緊調教部份分開。可以設定一個固定的鬆緊度，改善 **KHF57C** 夾子開閉後鬆緊度不一致的缺點。

**KHF57C2** have a special tension controller. The tension is fixed. Tension will not affect by the open and close of the device. It can solve the drawback of **KHF57C** whose tension is inconsistent after each open and close.

**KHF57AE / BE**

(鬆緊帶包縫 Elastic Binding)

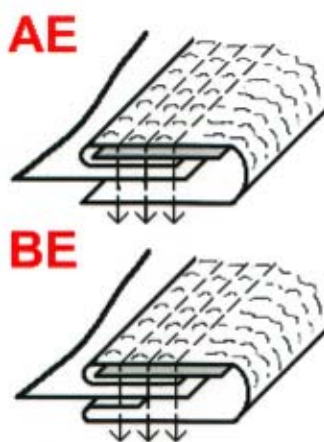

橡根 Elastic	入口 Tape	出口 Finished
<b>KHF57AE</b>		
1/4"	15/16"	5/16"
5/16"	1-1/8"	3/8"
7/16"	1-3/8"	1/2"
<b>KHF57BE</b>		
1/4"	1-1/4"	5/16"
5/16"	1-1/2"	3/8"
7/16"	1-3/4"	1/2"

**KHF57APP / BPP**

(突邊 Protruded Piping)

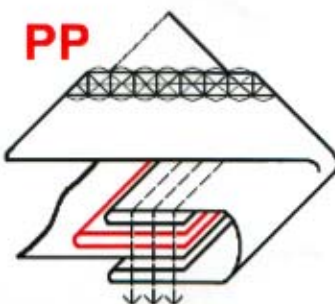

**PP** 突邊器沒有一定的尺寸。訂購時請說明尺寸及 **KHF57A** 或 **KHF57B** 所需要的尺寸。

**PP** Folder has no standard size. Please inform us the size of piping and also the size of **KHF57A** or **KHF57B** which would be combined with it.

**KHF 58**

包鬆緊帶捲邊器

Downturn Elastic Hemmer



橡筋尺寸 Size of Elastic

1"	1-1/8"	1-1/4"	1-3/8"
1-1/2"	1-3/4"	2"	

可用配件 Applicable Parts:

1. 關西多針車針位 Multi-needle Gauge Set for Kansai Special

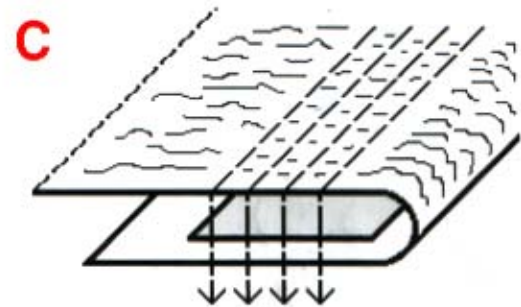
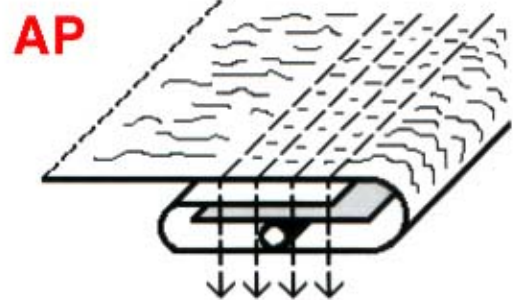
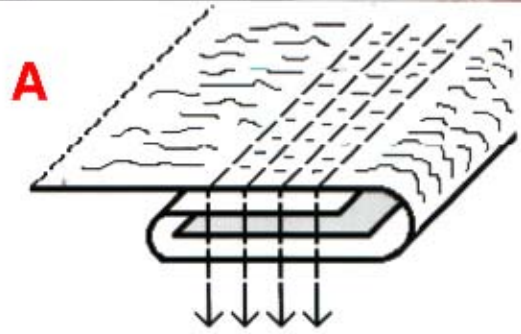

# KHF 59

## 人字縫包邊器

### Edge Binder (for Zigzag Sewing)

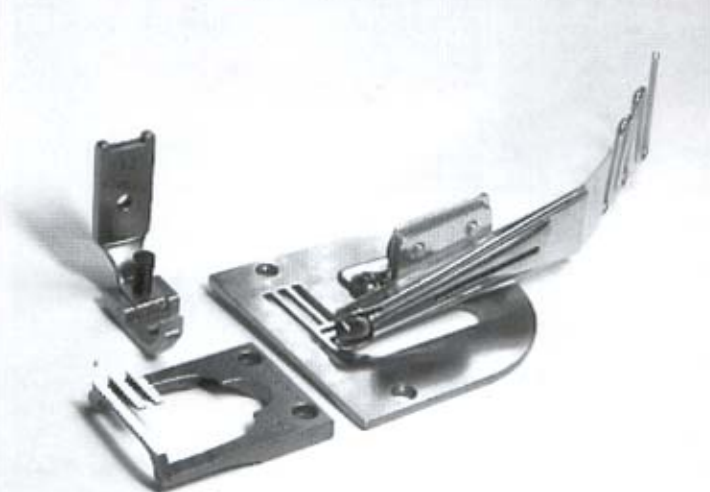

可用配件 Applicable Parts:

1. 210562A, 210516A, 210596A 壓腳、針板、牙 Presser Foot, Needle Plate, Feed Dog
2. 210569A, 210569B 壓腳 Presser Feet

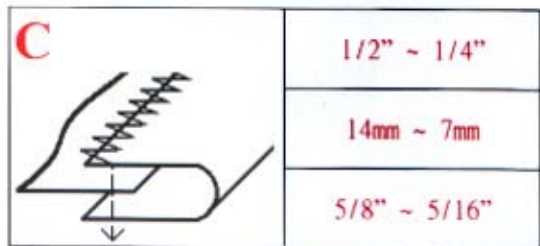
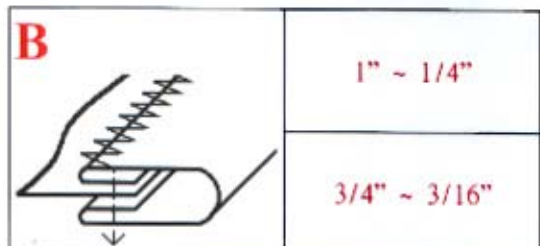
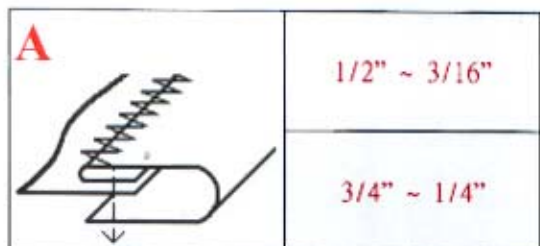

# KHF 60

## 管條包縫器

### Cord Piping for Overlock Machine

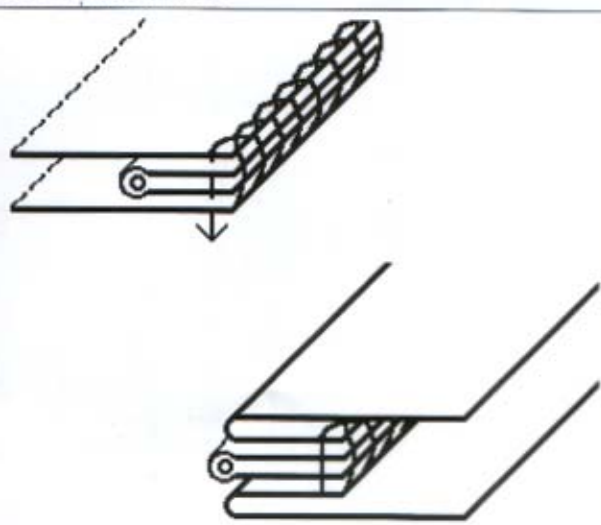

入口寬度 Tape Size	
5/8"	7/8"
3/4"	1"



**KHF 61**

襯衫前胸捲邊器 (單針車用)

Interlining Hemmer for Single Needle

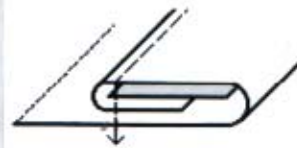
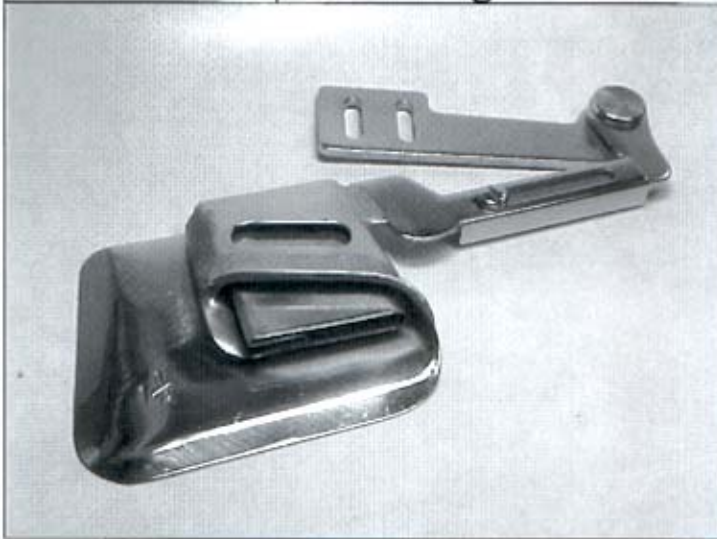

出口 Finished Size	
3/4"	1-1/4"
7/8"	1-3/8"
1"	1-1/2"
1-1/8"	

可用配件 Applicable Parts:

1. KL-13
2. CKL-13
3. KH7
4. 平車高低針板牙 Special Needle Plate & Feed Dog for Folders

**KHF 62**

繙縫車直角包邊器 (直插式)

Right Angle Binder for Covering Stitch Machine

**A**



**B**

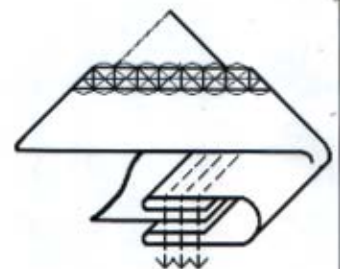

**KHF62A**

( 面環底散 Single Fold )

入口 Tape Size --- 出口 Finished Size

3/4"	1/4"
15/16"	5/16"
1-1/8"	3/8"
1-3/8"	1/2"
1-5/8"	5/8"
1-7/8"	3/4"
2-1/8"	7/8"
2-3/8"	1"
2-5/8"	1-1/8"
2-7/8"	1-1/4"
3-1/8"	1-3/8"
3-3/8"	1-1/2"

**KHF62B**

( 雙環口 Double Fold )

入口 Tape Size ---- 出口 Finished Size

1"	1/4"
1-1/4"	5/16"
1-1/2"	3/8"
1-3/4"	1/2"
2"	5/8"
2-1/4"	3/4"
2-1/2"	7/8"
2-3/4"	1"
3"	1-1/8"
3-1/4"	1-1/4"
3-1/2"	1-3/8"
3-3/4"	1-1/2"

**KHF62C**

(散口 Raw Edge)

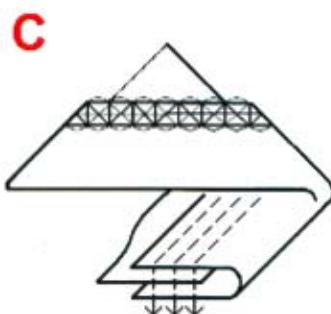

入口 Tape Size	出口 Finished Size
1/2"	1/4"
5/8"	5/16"
3/4"	3/8"
7/8"	7/16"
1"	1/2"



**C2**

KHF62C2 有特殊的鬆緊控制器，將夾子開關及鬆緊調教部份分開。可以設定一個固定的鬆緊度，改善 KHF62C 夾子開閉後鬆緊度不一致的缺點。

KHF62C2 have a special tension controller. The tension is fixed. Tension will not affect by the open and close of the device. It can solve the drawback of KHF62C whose tension is inconsistent after each open and close.

**KHF62AE / BE**

(鬆緊帶包縫 Elastic Binding)

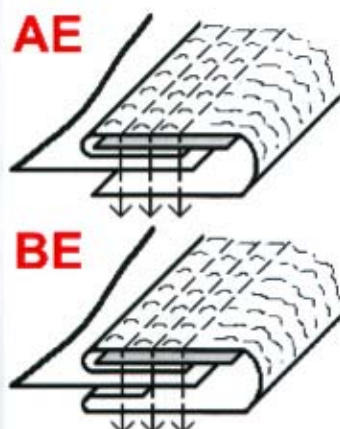

橡根 Elastic	入口 Tape	出口 Finished
<b>KHF62AE</b>		
1/4"	15/16"	5/16"
5/16"	1-1/8"	3/8"
7/16"	1-3/8"	1/2"
<b>KHF62BE</b>		
1/4"	1-1/4"	5/16"
5/16"	1-1/2"	3/8"
7/16"	1-3/4"	1/2"

**KHF62APP / BPP**

(突邊 Protruded Piping)



PP 突邊器沒有一定的尺寸。訂購時請說明尺寸及 KHF62A 或 KHF62B 所需要的尺寸。

PP Folder has no standard size. Please inform us the size of piping and also the size of KHF62A or KHF62B which would be combined with it.



**KHF 63**

雙針綑條貼邊器(胸圍及內褲用)

Lining Tape Attaching Folder for Brassieres and Underwear

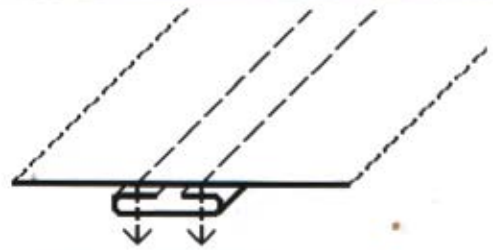

針距 Needle Space			
1/8"	1/4"	3/8"	1/2"
3/16"	5/16"	7/16"	

可用配件 Applicable Parts:

1. 21010 針位 Gauge Set
2. K41B

**KHF 64**

拉帶器

Belt Folder

單針及雙針車合用 For Single Needle & Double Needle Machine

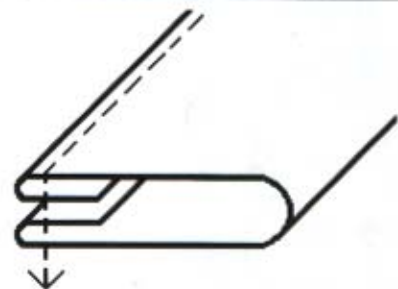
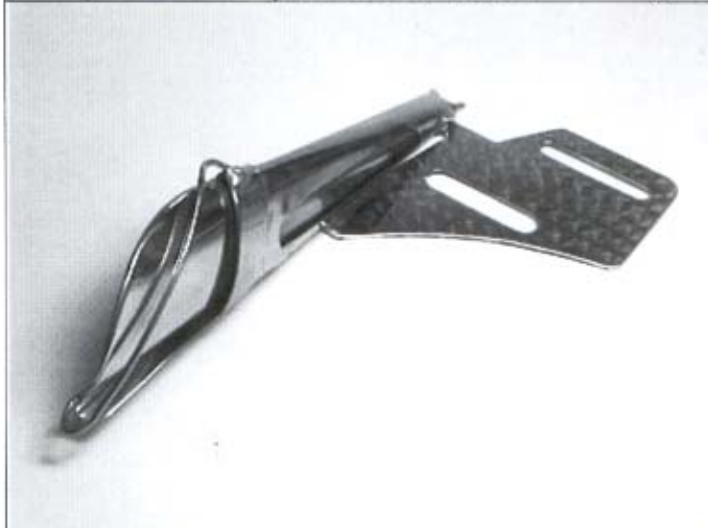

出口寬度 Finished Size		
3/16"	3/8"	3/4"
1/4"	1/2"	7/8"
5/16"	5/8"	1"



# KHF 65

## 雙針拉帶器

### Belt Loop Folder for Double Needle

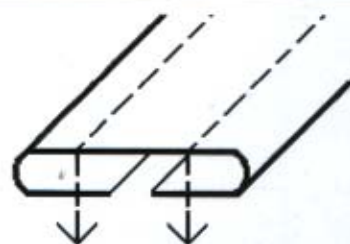

入口 Tape Size	出口 Finished Size
1"	1/2"
1-1/4"	5/8"
1-1/2"	3/4"
1-3/4"	7/8"
2"	1"

可用配件 Applicable Parts:

1. PD112x1, PD112x1.8 壓腳 Presser Feet

# KHF 66

## 細筒筒型車包邊器

### Binder for Small-sized Cylinder Bed Machine

薄物, 皮革及塑膠材料用 For Thin Leather and Plastic Material

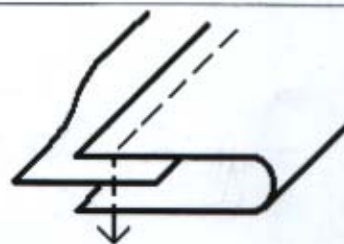

入口寬度 Tape Size
1/2"
5/8"
3/4"
7/8"
1"

**KHF 67**

飛馬包縫車包邊器

Edge Binder for Pegasus Overlock Machine

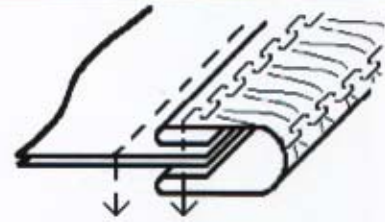
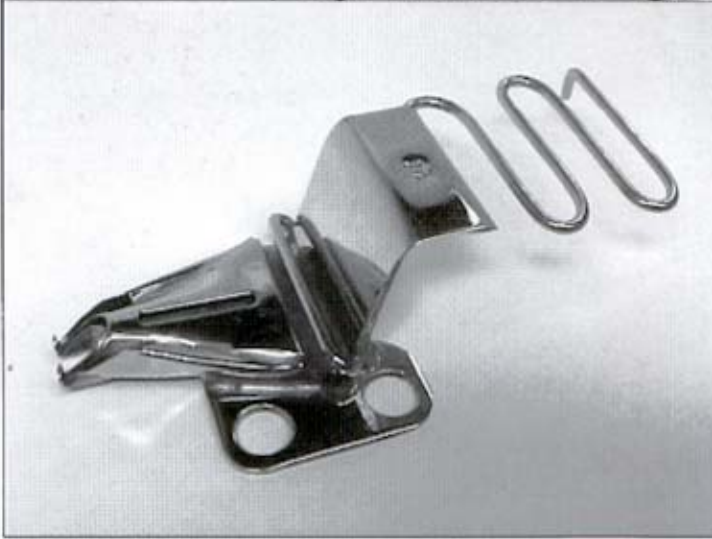

入口寬度 Tape Size	
22mm	26mm
24mm	28mm

**KHF 68**

胸罩襯裡貼邊包縫器

Lining Tape Attaching Folder for Cup Sewing (Swing Type)

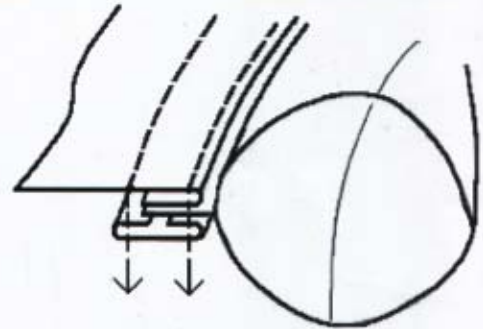

針距 Needle Space	
1/8"	5/16"
3/16"	3/8"
1/4"	

附件 Attached Parts:

1. K41B
2. KHF63



# KHF 69

## 包邊器 Edge Binder

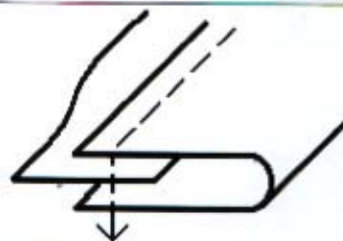

入口寬度 Tape Size		
22mm	24mm	26mm

支援機種 Machine Supported:

精工 SEIKO LSW-8BL

精工 SEIKO STH-8BL

祖奇 JUKI LU2-562, 563

祖奇 JUKI DNU-241

三菱 MITSUBISHI LU2-4420

可用配件 Applicable Parts:

1. 112607SP, 240144B, 240112HB

2. 524-2064B, 524-2063

3. U192B, U193B

# KHF 70

## 祖奇包縫車用包邊器 Edge Binder for JUKI Overlock Machine)



B	入口寬度 Tape Size	
		20mm
		22mm
		24mm
		26mm

C	入口寬度 Tape Size	
		1/2"



**KHF 71**

胸罩鋼線包縫器

Bra Underwire Support Attachment

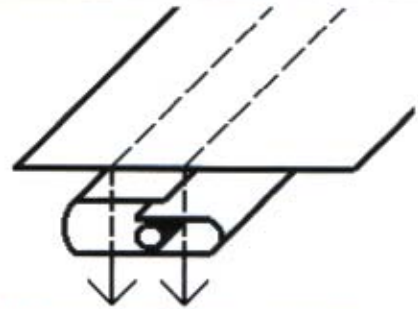

針位 Gauge Set	入口 Tape Size	出口 Finished Size
1/4"	1-1/8"	3/8"
1/4"	1"	3/8"
3/16"	15/16"	5/16"
1/8"	3/4"	1/4"

可用配件 Applicable Parts:

1. 21010 針位 Gauge Set
2. K41B 推板 Slide Plate

**KHF 72**

多條面貼器

Multi Tape Attach Folder



上面貼器  
Upper Folder



下面貼器  
Lower Folder

搭口 Overlapped

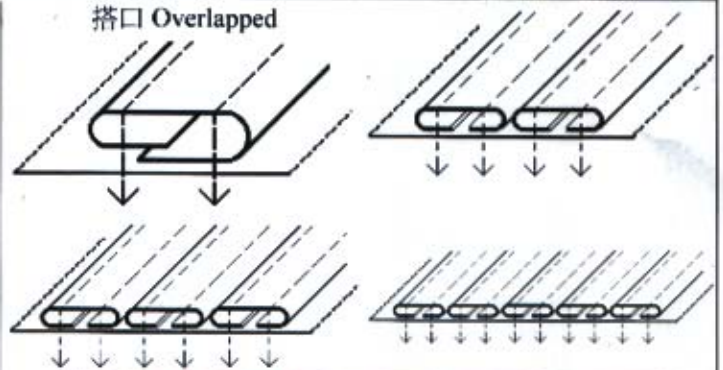

入口 Tape Size ~ 出口 Finished Size
5/8" ~ 1/4" 搭口 Overlapped
5/8" ~ 5/16"
3/4" ~ 5/16" 搭口 Overlapped
3/4" ~ 3/8"
7/8" ~ 3/8" 搭口 Overlapped
1" ~ 1/2"
1-1/8" ~ 1/2" 搭口 Overlapped
1-1/4" ~ 5/8"
1-3/8" ~ 5/8" 搭口 Overlapped
1-1/2" ~ 3/4"
1-3/4" ~ 7/8"

可用配件 Applicable Parts:

1. 關西多針車針位 Multi-needle Gauge Set for Kansai Special
2. KHF112 支架 Bracket

**KHF 73** 通心暗線縫拉帶器(連針板,牙,靴)  
Spaghetti Attachment (with Needle Plate, Feed Dog & Presser Foot)

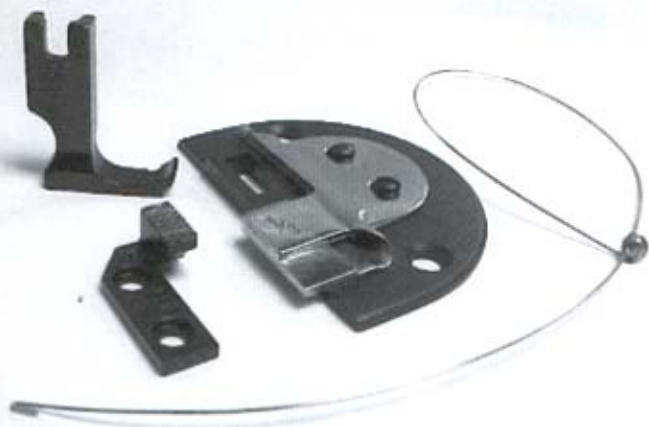

出口寬度 Finished Size	
1/8"	5/16"
3/16"	3/8"
1/4"	



出口寬度 Finished Size
1/2"

**KHF 74** 平車包邊器  
Edge Binder for Single Needle Machine

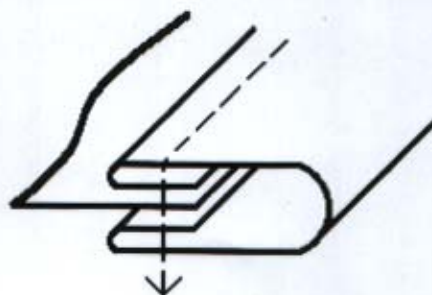

可用配件 Applicable Parts:

1. KL-13
2. CKL-13
3. KH7
4. 平車高低針板牙 Special Needle Plate & Feed Dog for Folders



**KHF 75**

平車包管條器面貼壓腳

Piping Folder Attaching Foot (Single Needle)

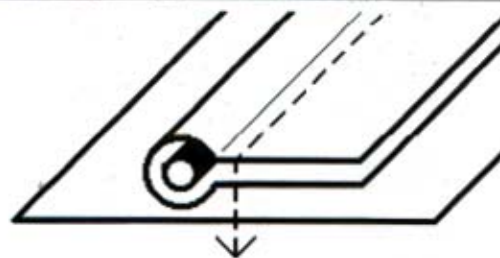

細條尺碼 Tape Size	繩仔最大直徑 Cord Max. Diameter
18mm	3. mm
20mm	
22mm	3.5mm
24mm	
26mm	

**KHF 76**

人字縫包邊器(胸罩用)

Brassiere Edge Binder for Zigzag Sewing

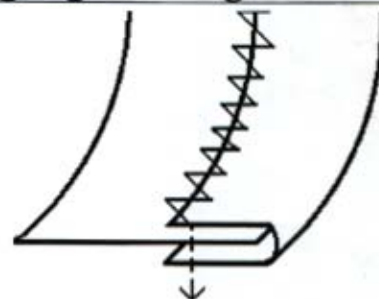
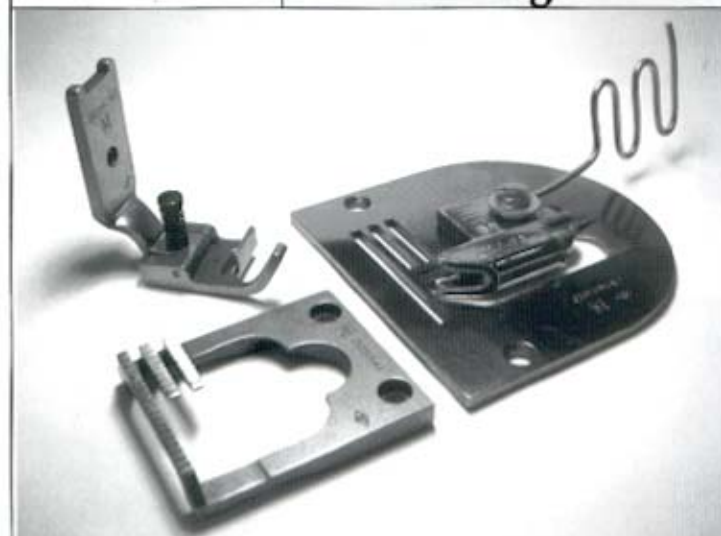

出口寬度 Finished Size		
5.2mm	6.4mm	8mm

可用配件 Applicable Parts:

- 210562A, 210516A, 210596A 壓腳、針板、牙  
Presser Foot, Needle Plate, Feed Dog 210569A,
- 210569B, 210569C



**KHF 77** 上下綑條包鋼線貼邊器(胸罩用)  
Two-piece Bra Underwire Support Attachment

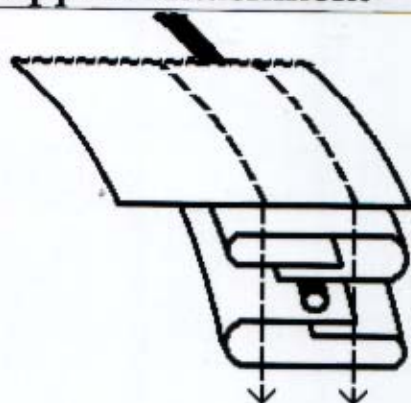
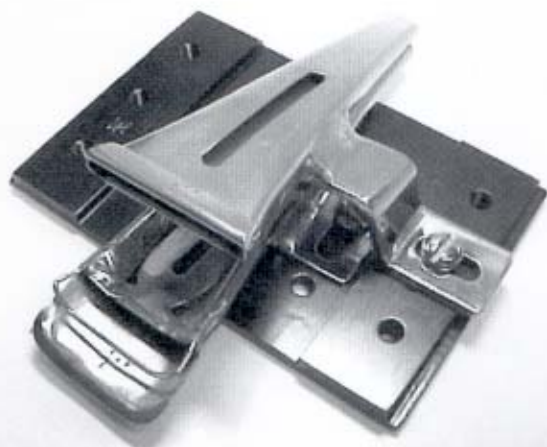

可用配件 Applicable Parts:  
1. K41B 推板 Slide Plate

入口 Tape Size: 1"  
出口 Finished Size: 3/8"  
針距 Needle Space: 1/4"

**KHF 78** 包鋼線貼邊器 (胸罩用)  
Bra Underwire Support Attachment

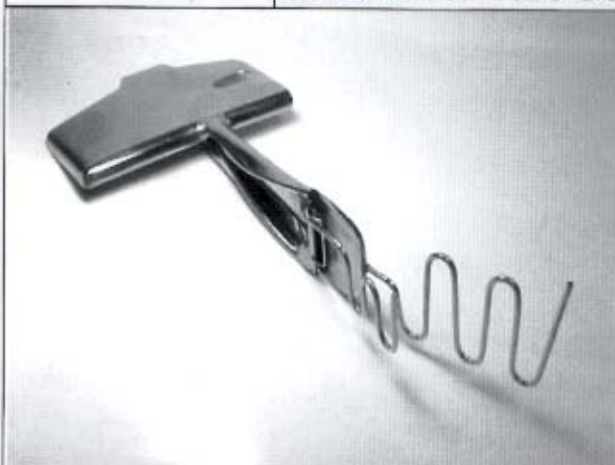

**KHF 79**

人字縫摺邊器 (胸罩用)

Brassiere Edge Binder for Zigzag Sewing

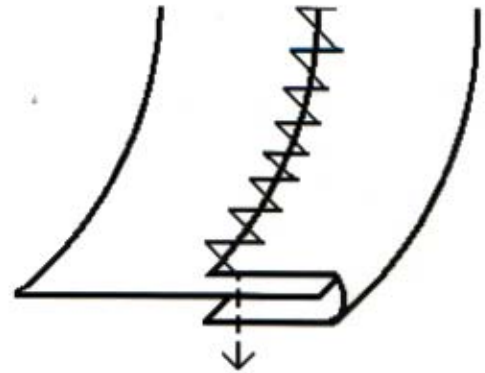
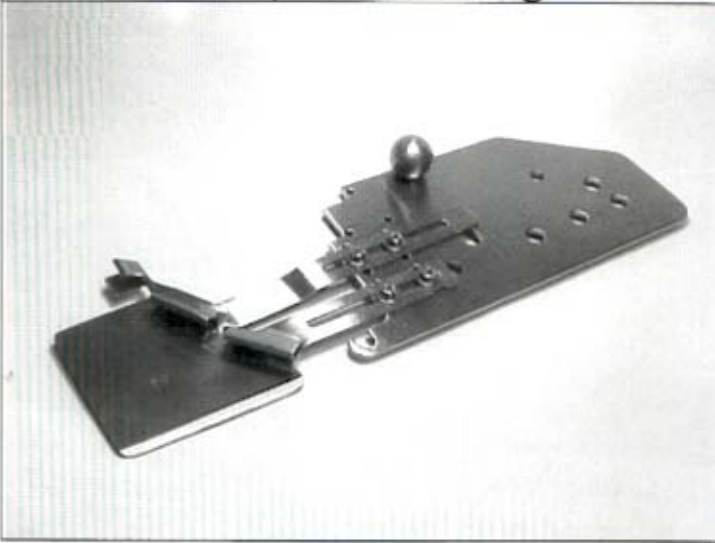

**KHF 80**

可調教摺邊器 (雙針用)

Adjustable Single Upturn Hemmer (2 Needle)

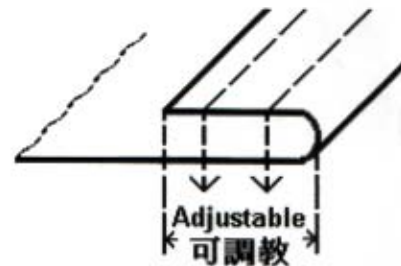

出口尺寸 Finished Size:

可在 1/8" 及 1/2" 之間調教

Can be adjusted between 1/8" and 1/2"

可用配件 Applicable Parts:

1. PL112x1, PL112x1.8

**KHF 81** 可調教式花邊摺邊器  
Adjustable Lace Attaching Folder

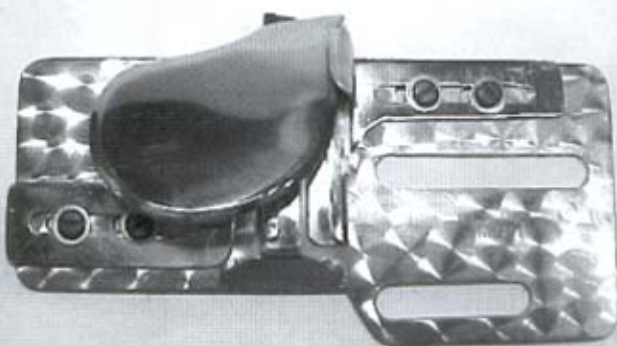
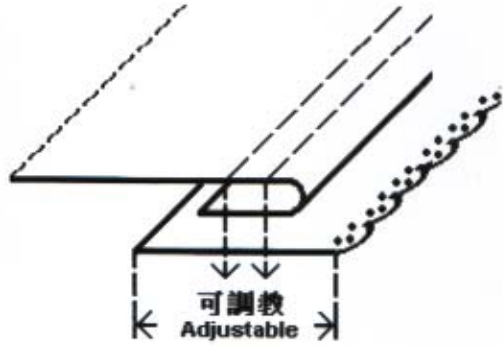
可調教  
Adjustable

**KHF 82** 管條包縫器 (飛馬包縫車用)  
Piping Folder (for Pegasus Overlock Machine)

入口寬度 Tape Size		
20mm	24mm	28mm
22mm	26mm	

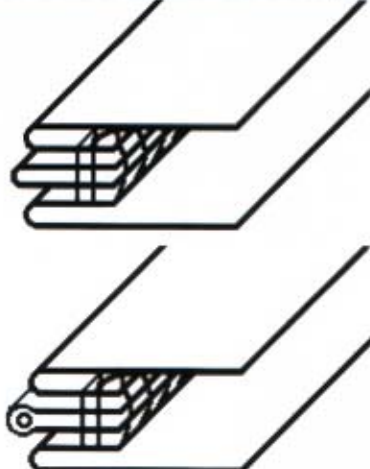

**KHF 83**

繙縫車綑條面貼器

**Tape Attach Folder (for Covering Stitch)**

可置在繙縫車壓腳前 Installed in front of the Covering Stitch Presser Foot

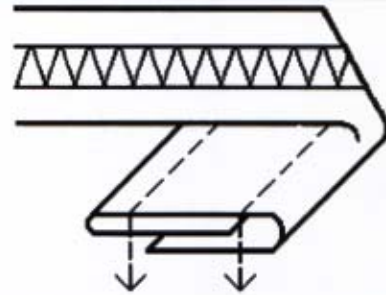
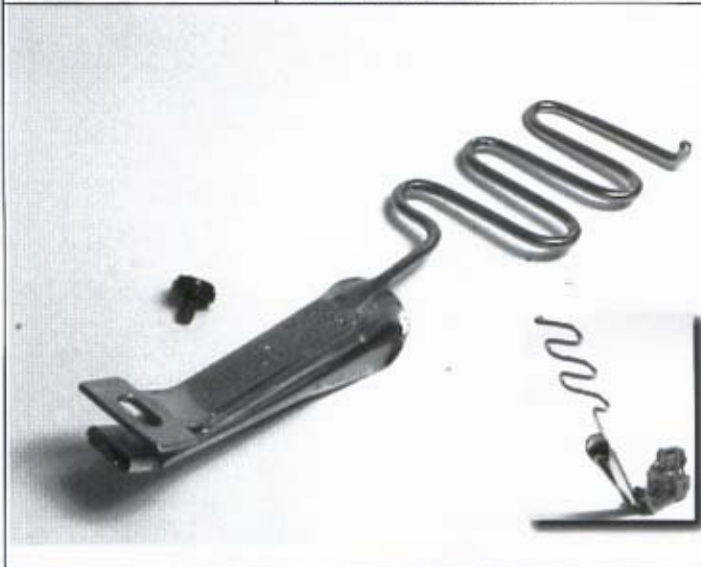

入口Tape Size	出口Finished Size
14mm	5.6mm
15mm	6.4mm
17mm	7.2mm
19mm	8.0mm
21mm	8.8mm

**KHF 84**

可調教式繙縫車摺邊器

**Adjustable Downturn Folder (for Covering Stitch)**

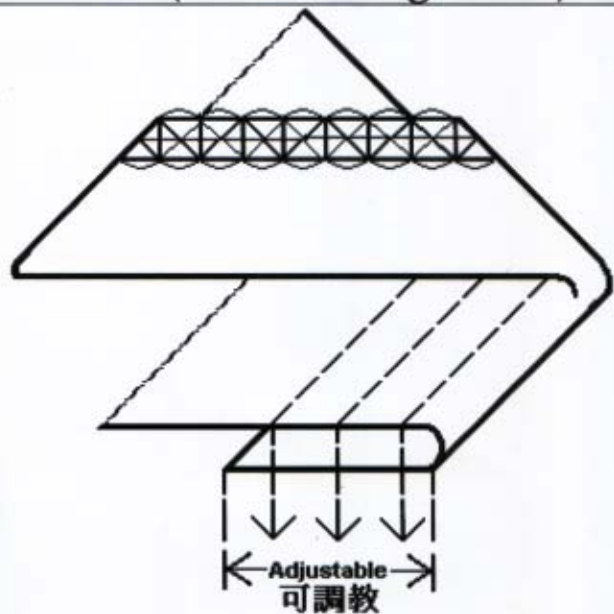
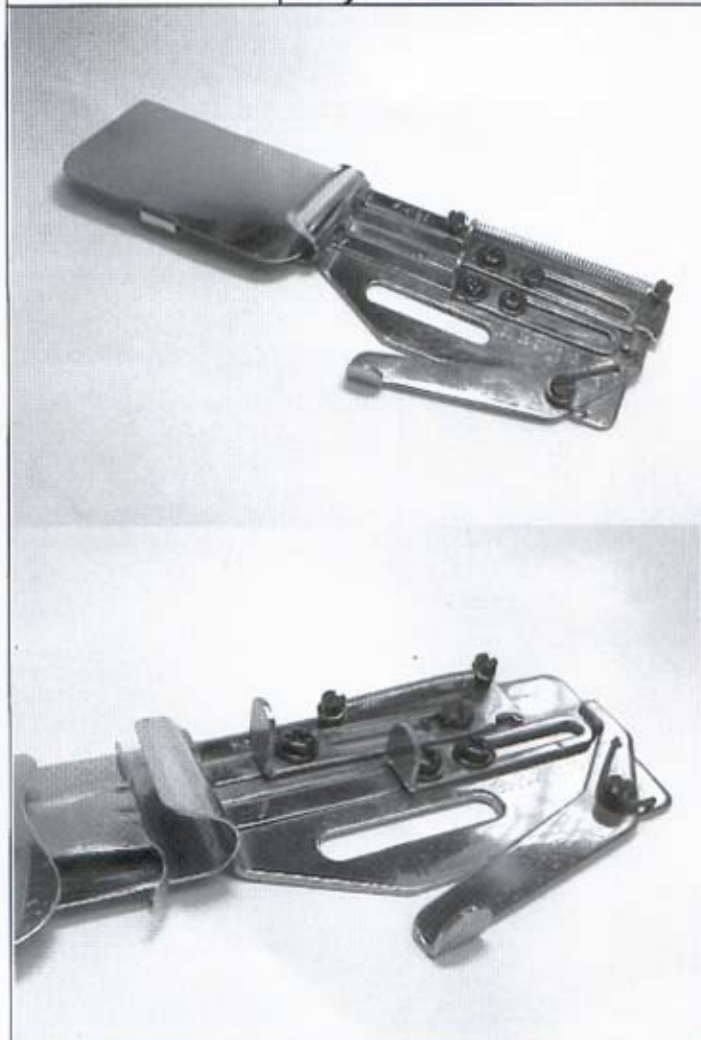

出口寬度Finished Size :  
 可在 10mm 至 30mm 之間調教  
 Can be adjusted between 10mm and 30mm

## KHF 85 上下兩層拉帶器 Two Piece Belt Loop Folder

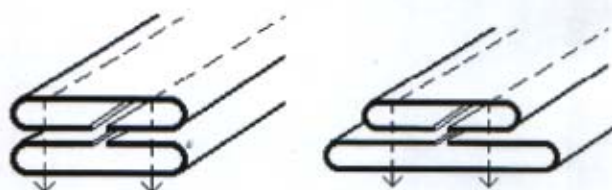
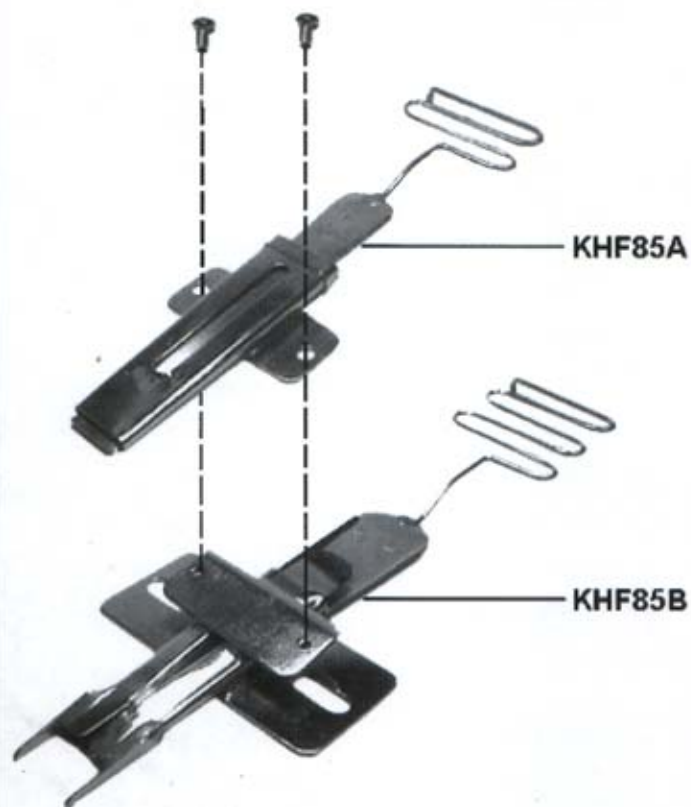

入口 Tape Size	出口 Finished Size
1-1/4"	5/8"
1-1/2"	3/4"
1-3/4"	7/8"
2"	1"
2-1/4"	1-1/8"
2-1/2"	1-1/4"
2-3/4"	1-3/8"
3"	1-1/2"

可用配件 Applicable Parts:

1. PD112x1, PD112x1.8 壓腳 Presser Feet
2. 雙針針位 Double Needle Gauge Set

## KHF 86 懸掛式拉帶器 Suspended Tape Folder

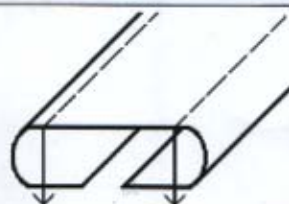

**KHF 86-1**

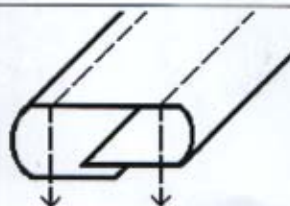

**KHF 86-2**

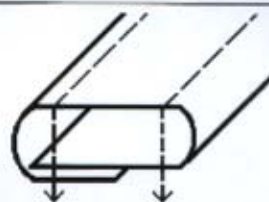

**KHF 86-3**

可用配件 Applicable Parts:

1. KHF-111 支架 Folder Bracket



**KHF 87**

包芯手挽帶拉器

Strap Folder with Cord

( 雙針車單針用, 1 needle operation on 2 needle machine )

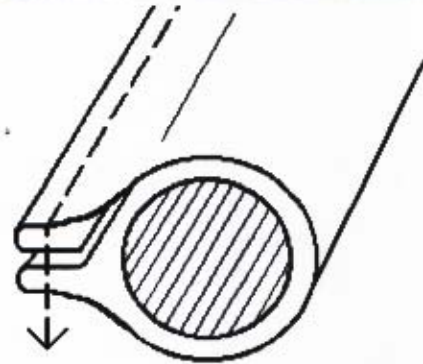

可用配件 Applicable Parts:

1. K224060S
2. PH112W

**KHF 88**

開合擺動式摺邊器

Latch Top Swing Hemmer

( 圓桶式摺袖摺腳合用 for Circular Sleeve or Bottom Hemming )

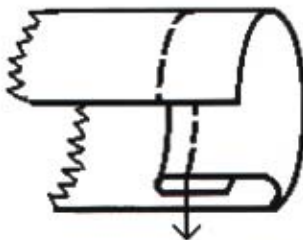

出口寬度 Finished Size

1/2"

1"

3/4"

1-1/4"



**KHF 89**

**可調教繙縫車摺邊器**

**Adjustable Down-turn Folder for Covering Stitch**

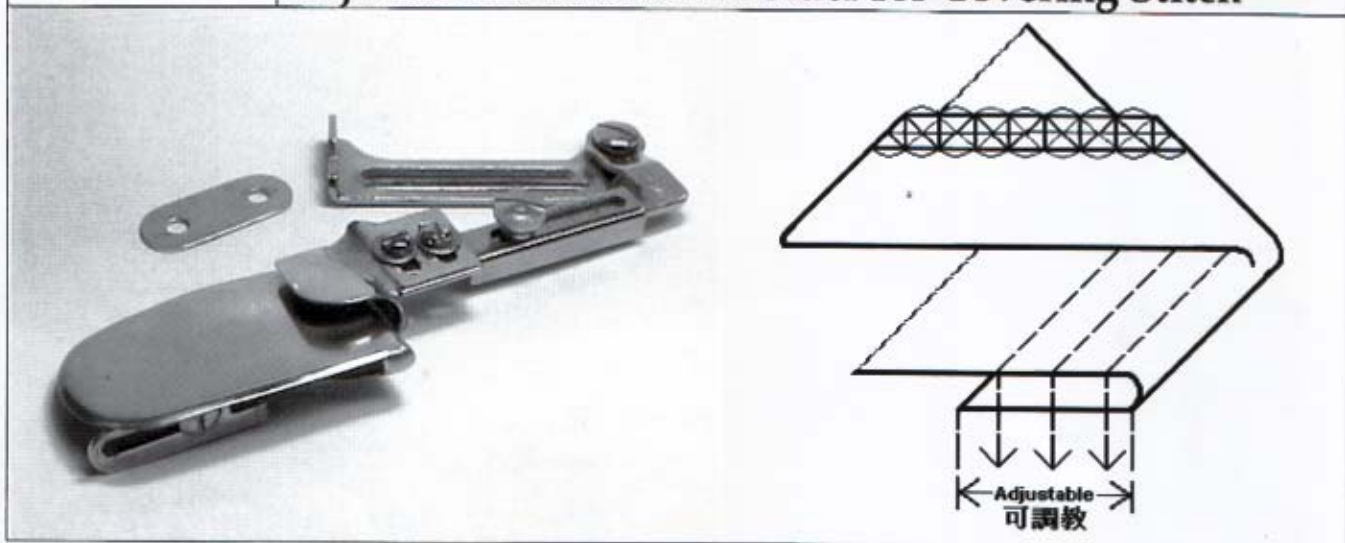

**KHF 90**

**工字褶摺縫器**

**Box Pleat Folder**

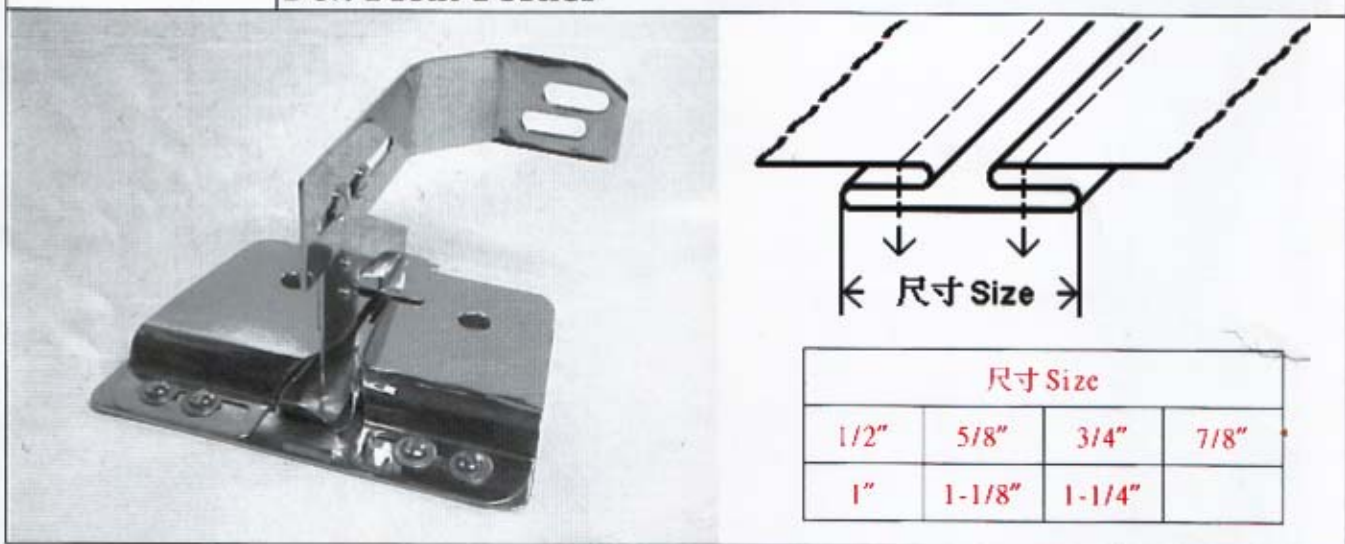

**KHF 91**

細筒筒型車包邊器

Binder for Small-sized Cylinder Bed Machine

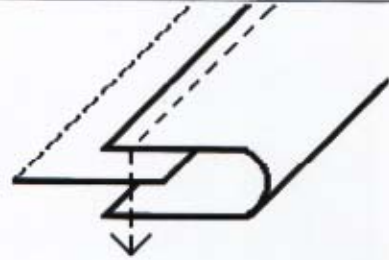

入口寬度 Tape Size		
1/2"	3/4"	1"
5/8"	7/8"	

可用配件 Applicable Parts:

1. 筒型車包邊壓腳

Cylinder-bed Machine Presser Foot for Folder

**KHF 92**

胸圍鋼線包縫器

Bra Underwire Support Attachment

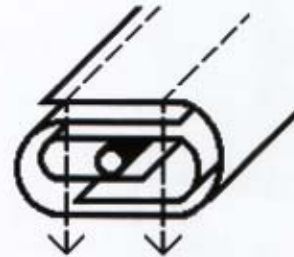

KHF92	S	L
外層入口 Outer Tape Size:	22mm	25mm
內層入口 Inner Tape Size:	20mm	23mm
出口 Finished Size:	8mm	10mm
針距 Needle Space:	1/4"	5/16"

# KHF 93

## 帽子助縫器 Hat & Cap Attachment

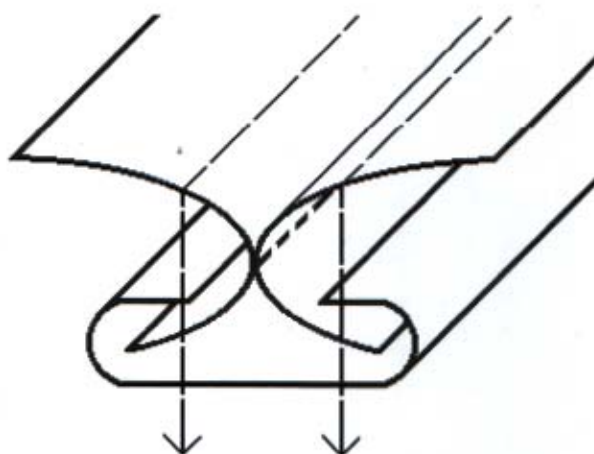

入口寬度 Tape Size	出口寬度 Finished Size
1"	9/16"
1-1/8"	9/16"

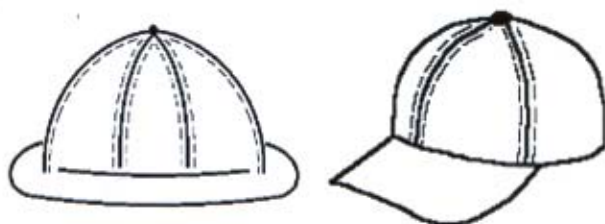

# KHF 94

## 曲折圓腳捲邊器 Sewing Hemmer for Meandering Egdes

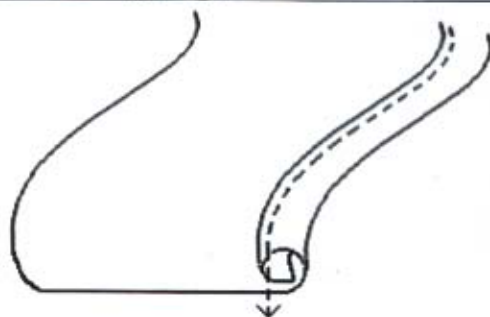

尺寸 Size	
1/8"	3/16"
1/4"	3/8"



# KHF 95

## 開袋口裝置(雙針車用)

Attachment for Pocket Welting (for 2 needle machine)

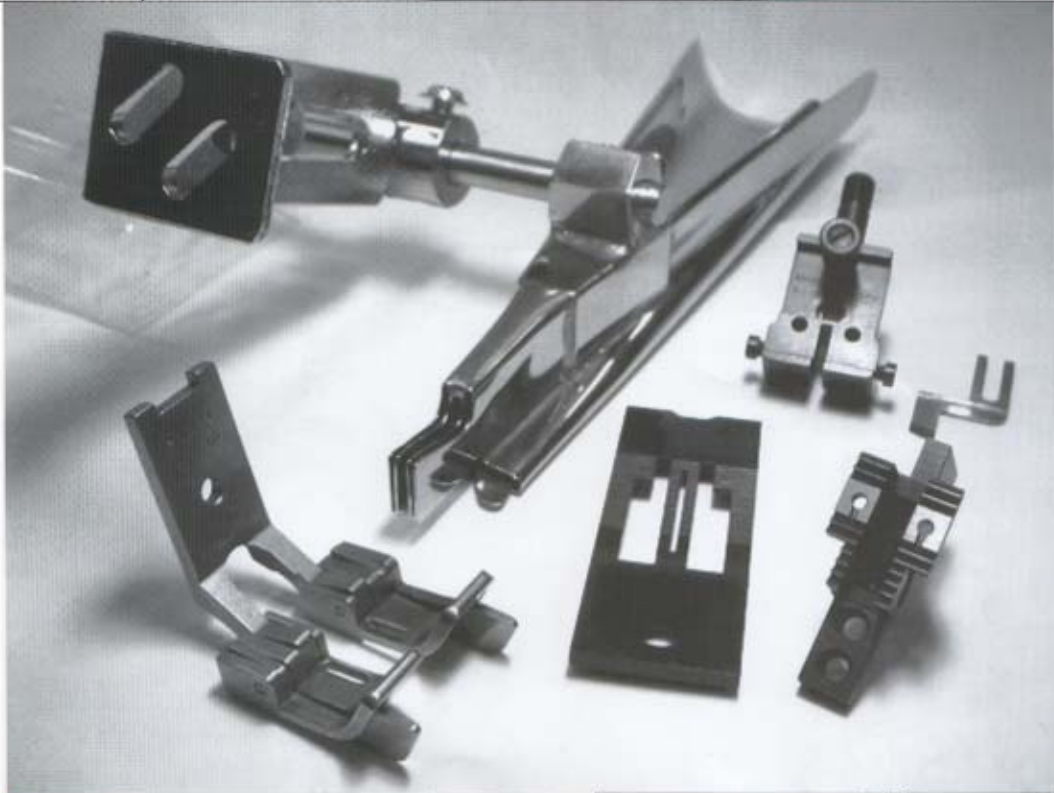

<b>KHF95</b>	夾摺器及支架 Folder only with bracket
<b>KHF95-GS:</b>	針位 Gauge Set
<b>KHF95-PF</b>	壓腳 Presser Feet
<b>KHF95-NP</b>	針板 Needle Plate
<b>KHF95-FD</b>	送布齒 Feed Dog
<b>KHF95-NC</b>	針具 Needle Clamp
<b>KHF95-CK</b>	切刀 Knife

針距尺寸 Needle Space	
10mm	12mm

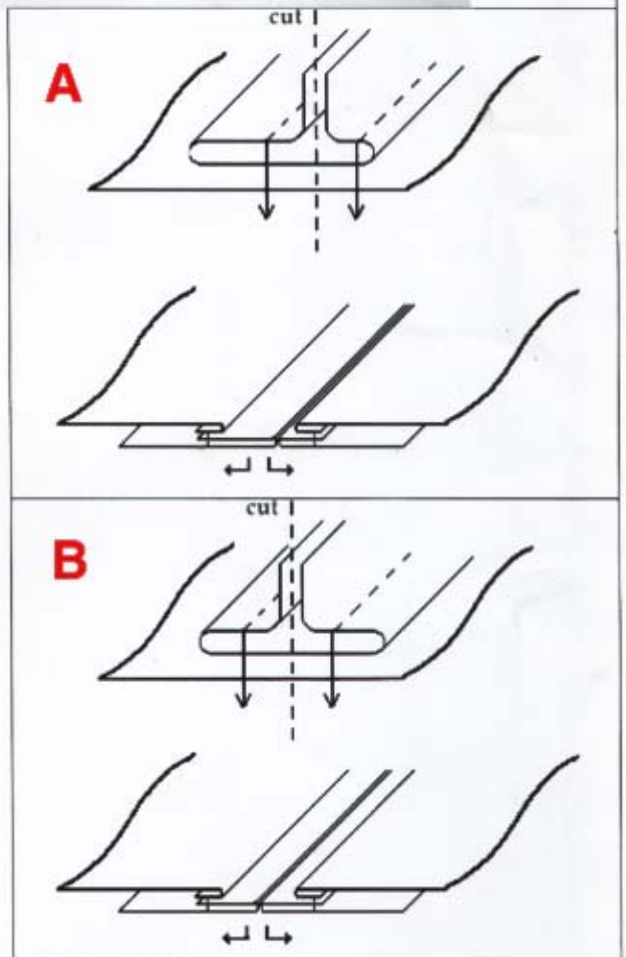
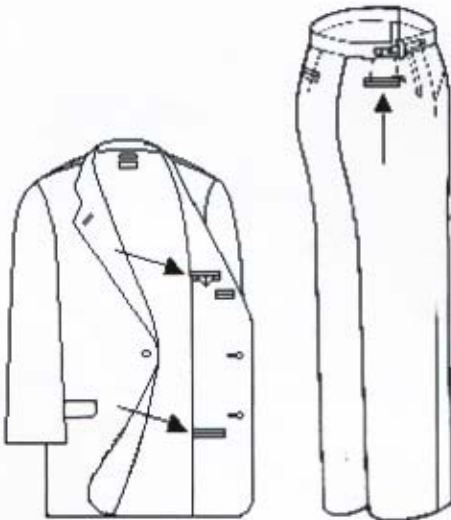

**KHF 96**

胸罩用包硬片面貼器

Brassiere Strip Support Attachment

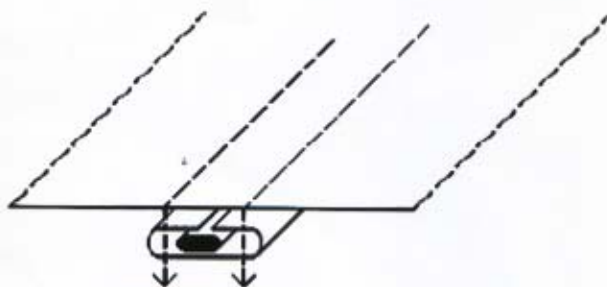

針距 Needle Space: 1/4"

**212-96**

硬片導坑壓腳

Grooved Presser Foot for Strip



**KHF 97**

三重捲包硬片面貼器(胸罩用)

Triple Folded Brassiere Strip Support Attachment

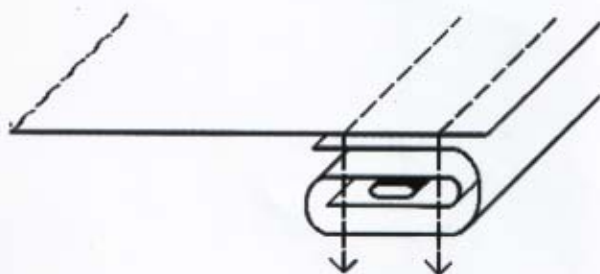

1. 針距 Needle Space: 3/16"  
入口 Tape Size: 30mm
2. 針距 Needle Space: 1/4"  
入口 Tape Size: 40mm

**KHF 98**

單針打摺器

Single Needle Tucking Attachment

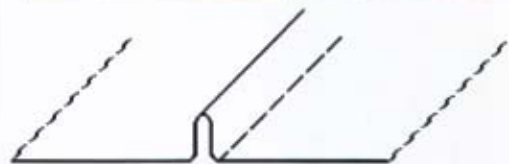
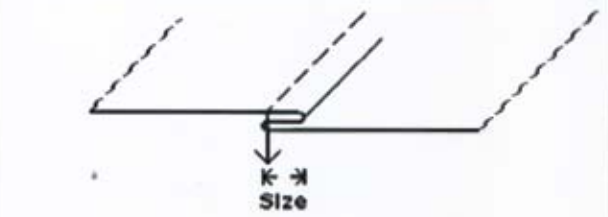

尺寸可以自由調教  
The size of folder is adjustable.

<b>SP98</b>	單針坑底壓腳 Grooved Presser Foot for 1-Needle	
尺寸 Size:	1/8"	3/16"

**KHF 99**

包鋼線貼邊器 (直角曲咀)

Bra Underwire Support Attachment (Right Angle)

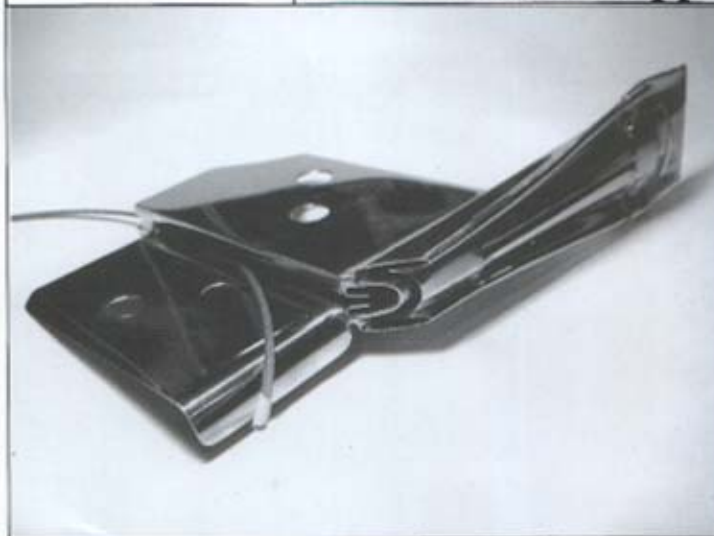

針距 Needle Space	入口 Tape Size	出口 Finished Size
3/16"	1-1/4"	5/16"
1/4"	1-1/2"	3/8"



**KHF 100** 平車直角包邊器  
Right Angle Binder

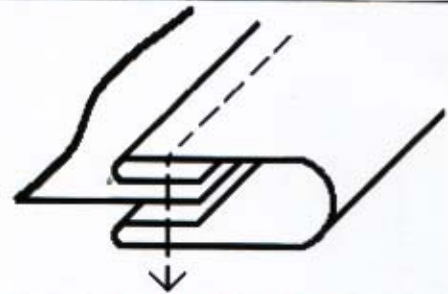
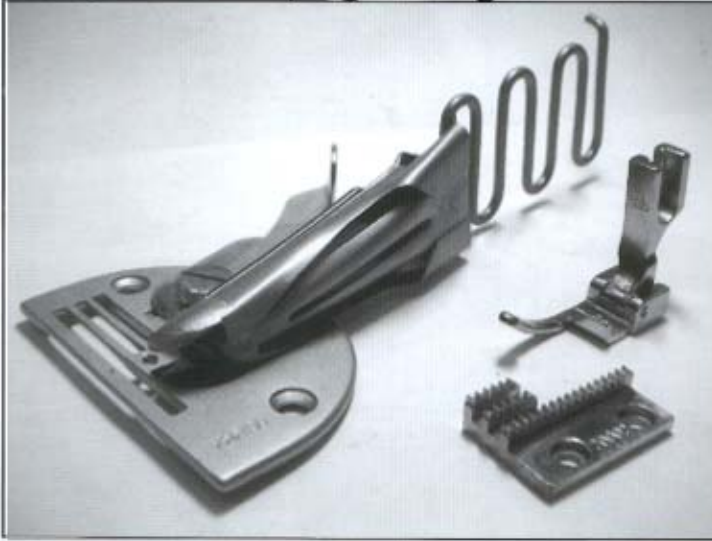

入口寬度 Tape Size			
3/4"	7/8"	1"	1-1/8"
1-1/4"	1-3/8"	1-1/2"	

(包括 KR-10 壓腳及 20002 送布齒)  
(Include KR-10 presser feet and 20002 feed dog)

**KHF 101** 單針接袖器 (搭接第一部份)  
Single Needle Sleeves Attachment (1<sup>st</sup> part of lap seam)

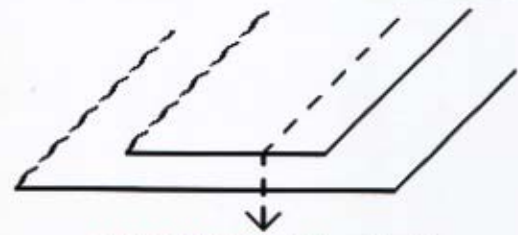
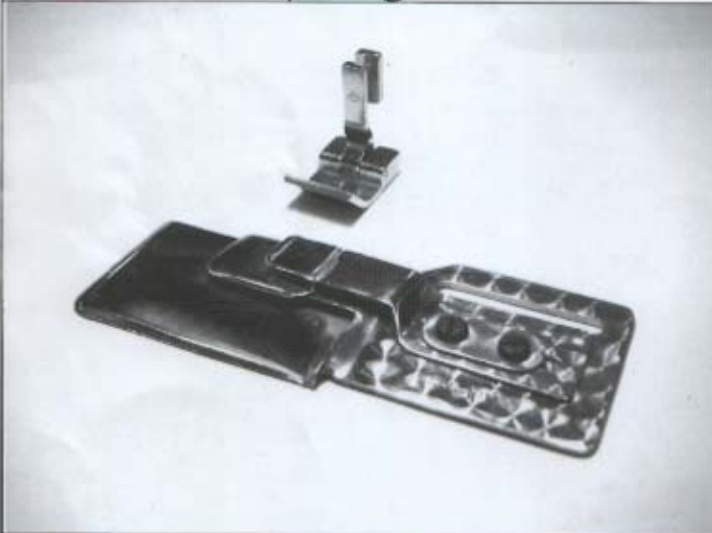

可自由調教尺寸 Adjustable Size

可用配件 (不包括於 KHF101 內):  
Applicable part (not included in KHF101):  
1. P3620 壓腳 Presser Foot  
2. KH5NP & KH5FD 針板、牙 Needle Plate and Feed Dog

**KHF 102**

單針接袖器 (搭接第二部份)

Single Needle Sleeves Attachment (2<sup>nd</sup> part of lap seam)

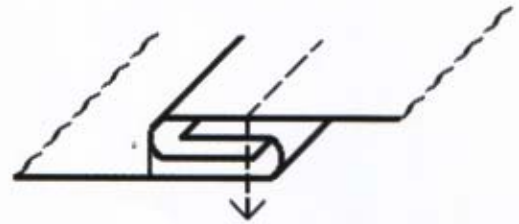

可用配件 (不包括於 KHF101 內):

Applicable part (not included in KHF101):

1. SP102 壓腳 Presser Foot
2. KH5NP & KH5FD 針板、牙 Needle Plate and Feed Dog

**KHF 107**

人字暗縫面貼壓腳

Zigzag Blind Stitch Tape Attaching Foot

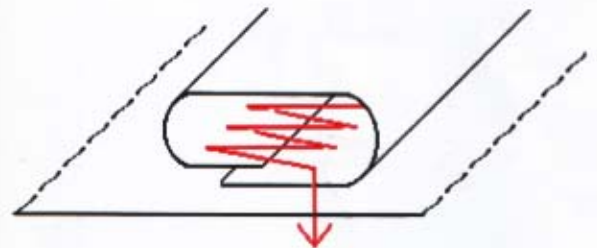
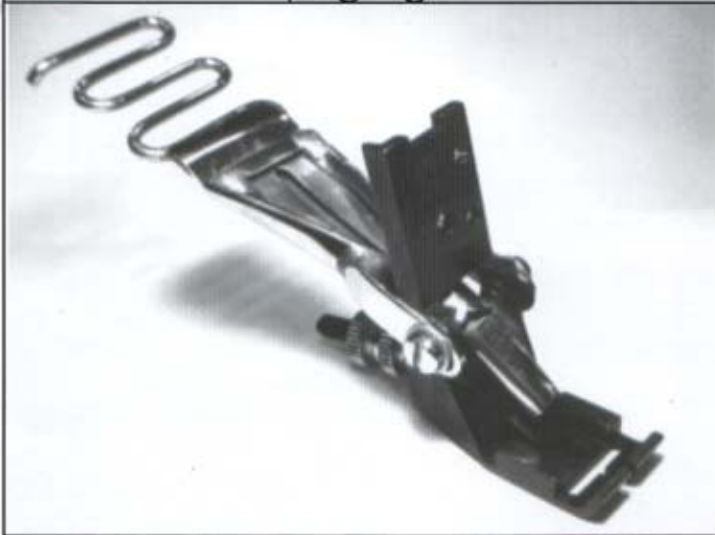

# KHF 711 綑縫車直角包邊器(水平式) Right Angle Binder for Covering Stitch Machine

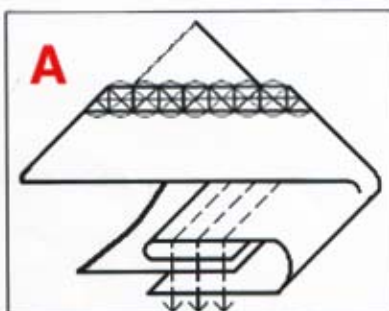
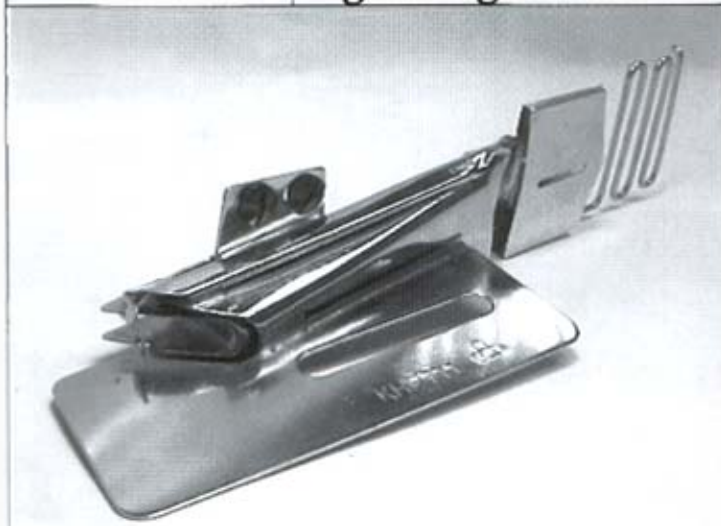

入口 Tape Size	出口 Finished Size
3/4"	1/4"
15/16"	5/16"
1-1/8"	3/8"
1-3/8"	1/2"
1-5/8"	5/8"
1-7/8"	3/4"
2-1/8"	7/8"
2-3/8"	1"
2-5/8"	1-1/8"
2-7/8"	1-1/4"
3-1/8"	1-3/8"
3-3/8"	1-1/2"

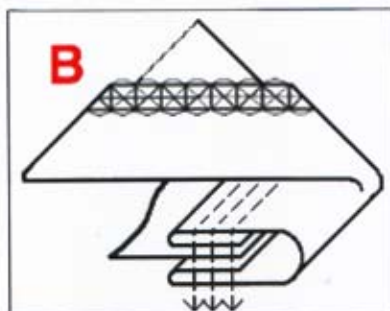

入口 Tape Size	出口 Finished Size
1"	1/4"
1-1/4"	5/16"
1-1/2"	3/8"
1-3/4"	1/2"
2"	5/8"
2-1/4"	3/4"
2-1/2"	7/8"
2-3/4"	1"
3"	1-1/8"
3-1/4"	1-1/4"
3-1/2"	1-3/8"
3-3/4"	1-1/2"

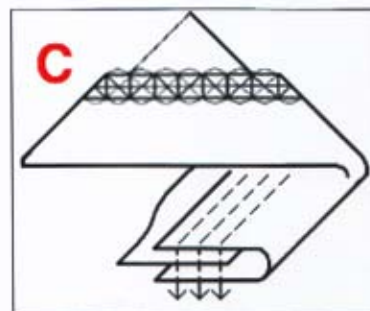

入口 Tape Size	出口 Finished Size
1/2"	1/4"
5/8"	5/16"
3/4"	3/8"



# KHF-1412PTV

## 1412PTV 打褶助縫器

### 1412PTV Pin-tucking Attachment

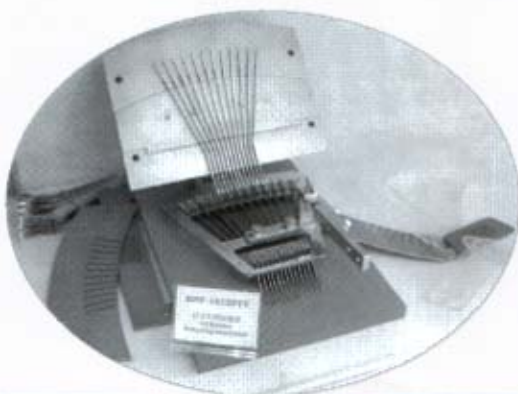
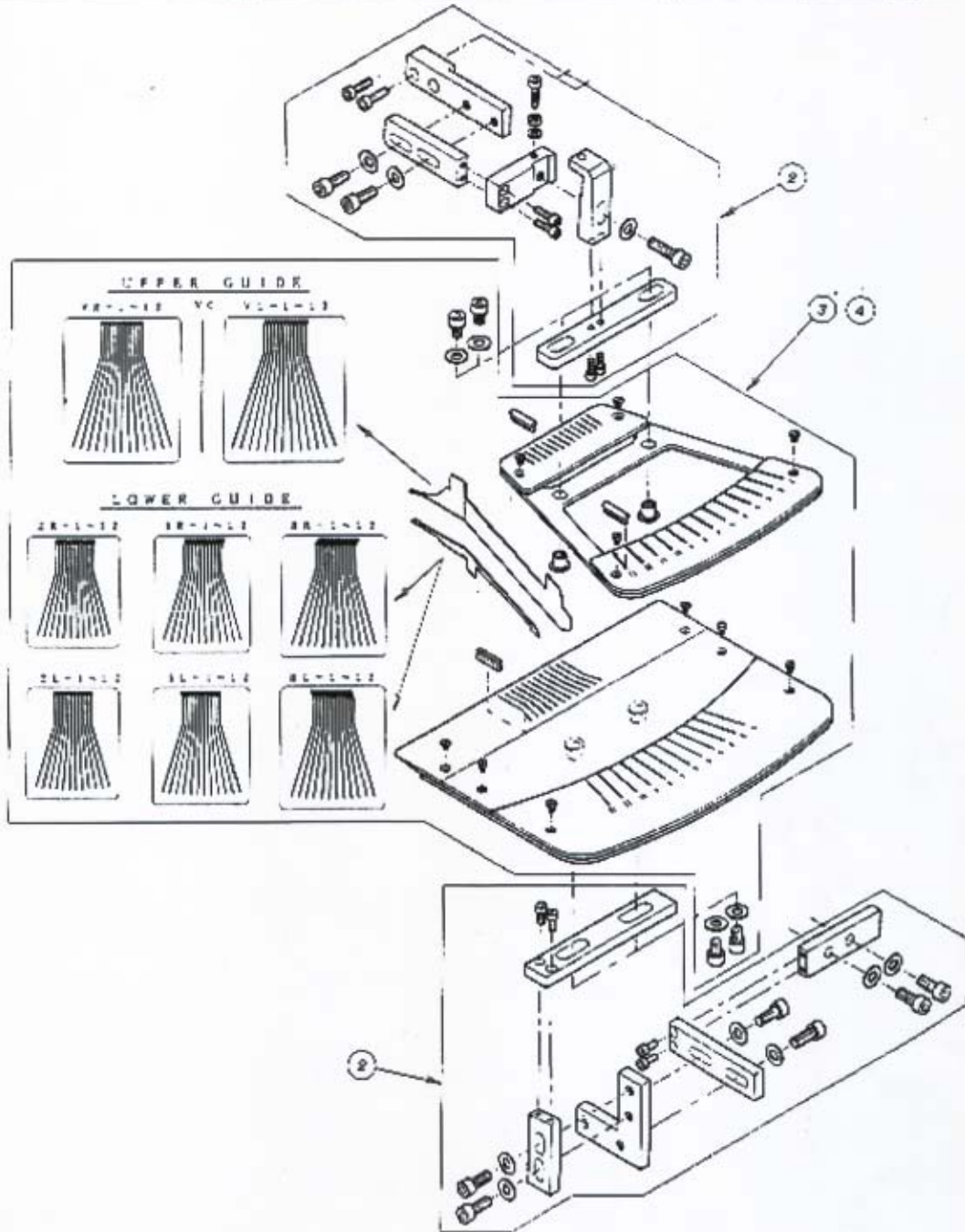

針距 Gauge Set

3/16"

1/4"

**KHF 747** 管條包縫器 (銀箭 747 用)  
Cord Piping Folder for Siruba 747

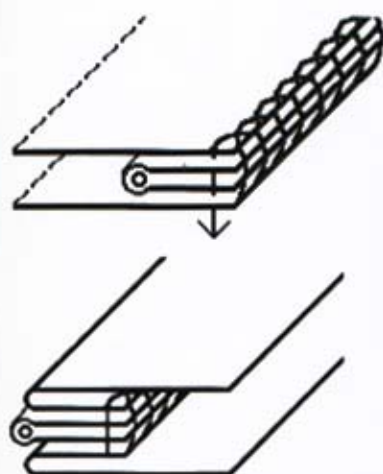

入口寬度  
Tape Size

3/4"

7/8"

1"

管條突邊導縫器  
Cord Piping Attachment

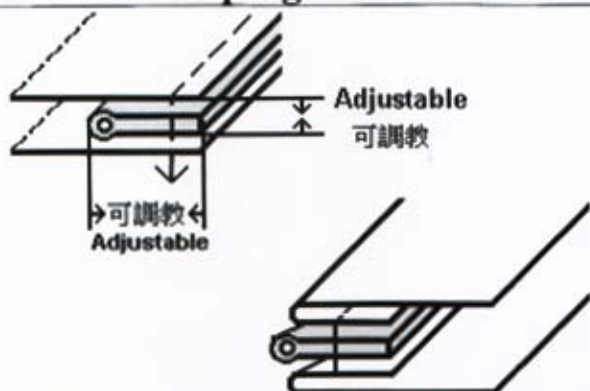

**KH341T**  
筒型車用  
For Cylinder-bed Machine



**KHY350T**  
平車用  
For Single Needle Machine





## 平車直角包邊器 Right Angle Bias Binder

### A10

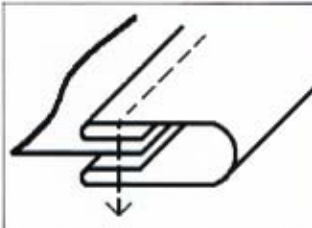

入口寬度 Tape Size		
18mm	28mm	38mm
20mm	30mm	40mm
22mm	32mm	42mm
24mm	34mm	45mm
50mm		

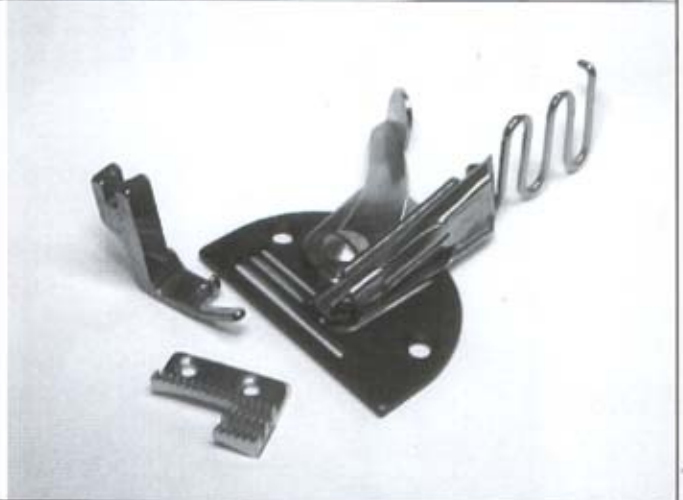

### K10

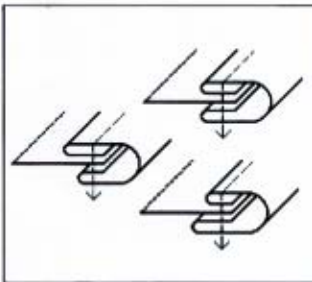

入口寬度 Tape Size		
18mm	28mm	38mm
20mm	30mm	40mm
22mm	32mm	42mm
24mm	34mm	45mm
26mm	36mm	48mm
50mm		

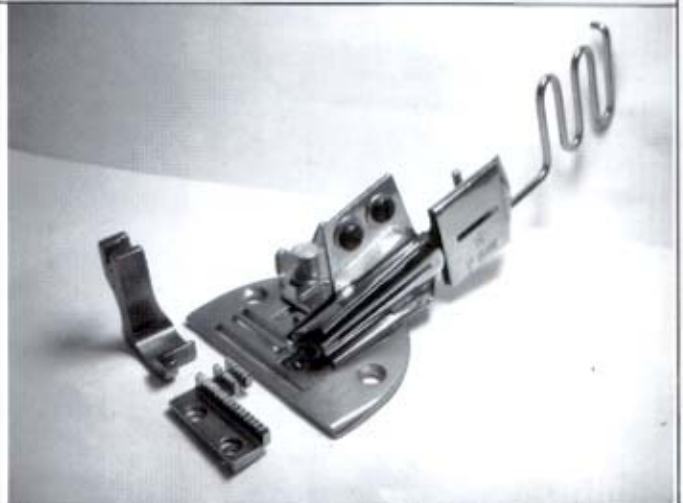

### TR-15

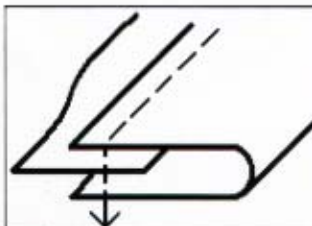

入口寬度 Tape Size	
1/2"	1"
5/8"	1-1/8"
3/4"	1-1/4"
7/8"	





平車直角包邊器 Right Angle Binder

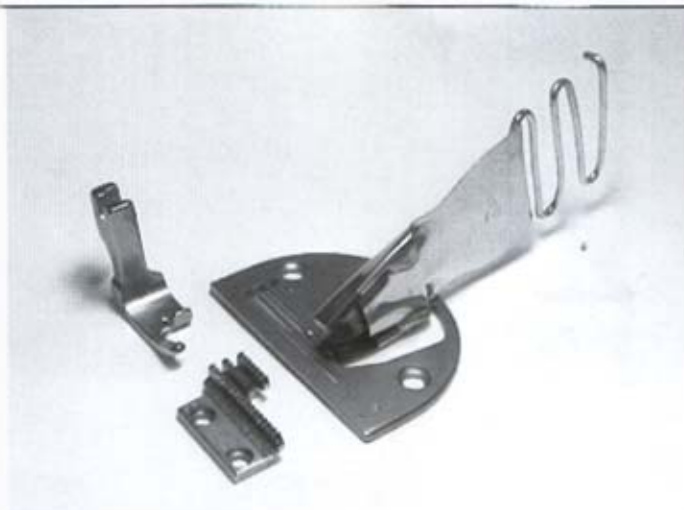

**LP3**

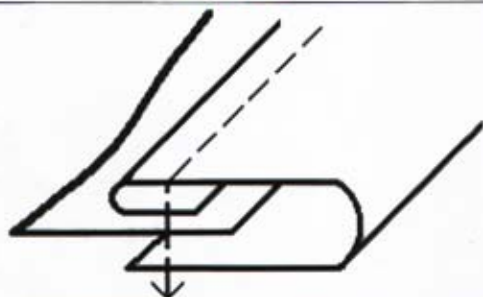

入口寬度 Tape Size

5/8"

7/8"

3/4"

1"

**LP4**

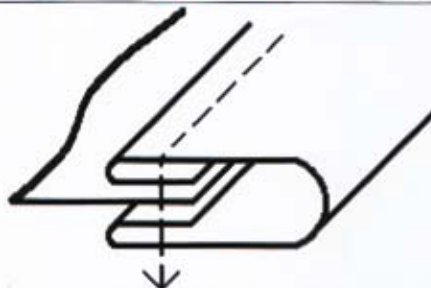

入口 Tape Size ~ 出口 Finished Size

3/4" ~ 3/16"

1" ~ 1/4"

1-1/8" ~ 5/16"

1-1/4" ~ 3/8"

**AT-18**

平車直角包邊器  
Right Angle Binder

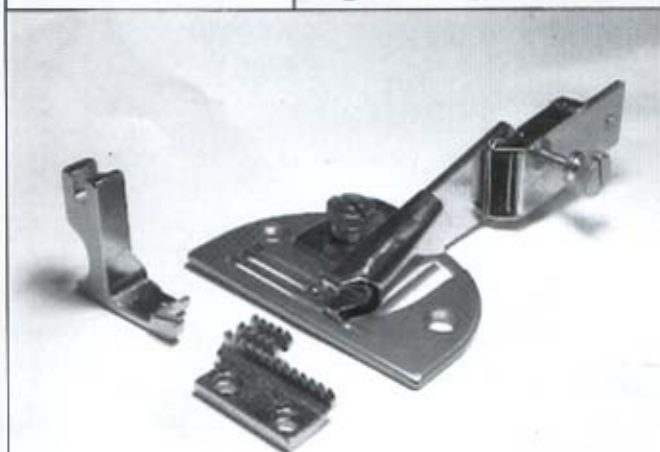

薄物・皮革物料合用

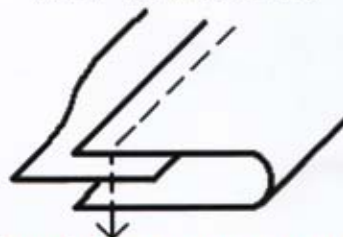

入口寬度 Tape Size : 18mm

## 各類助縫器支架 Brackets for KHF Folder

### KHF111

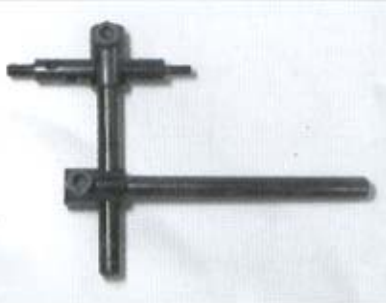

兩邊不同的螺絲可配合  
大部分型號的雙針車及綳縫車。

Two different screw on both end can be suitable for most of  
double needle machine and covering-stitch machine.

螺絲直徑 Diameter of Screw :

A: 5mm B: 4mm

螺紋間距 Thread Space:

A: .0.8mm B: 0.7mm

支架長杆直徑 Diameter of the long bar:8mm

### KHF112



### KHF122



### KHF162



### KHF528



### KHF622



### KG52-747



### KHF32-PN/PW



**KHF32-PN**

窄導板 Narrow Lapper Guide Plate

**KHF32-PW**

闊導板 Wide Lapper Guide Plate

**23420**

邊縫搭接捲邊器(美式埋夾)  
Lap Seam Feller (American Style)

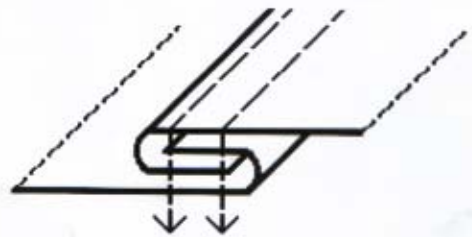

厚度 Thickness			
S	M	L	XL

**23564**

於仁 63900 縫紉機用捲邊器  
Hemmer for Union Special Class 63900  
(圓桶式摺袖摺腳合用 for Circular Sleeve or Bottom Hemming)

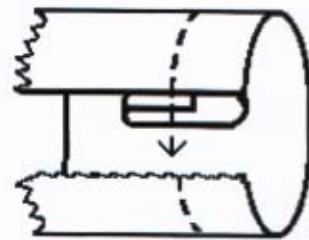

厚度 Thickness		
S	M	L

**63920** 壓腳 Presser Foot

尺寸 Size  
3/8", 1/4", 5/8", 3/4", 7/8", 1"





### 107-029

人字可調教花邊面貼壓腳  
Zigzag Adjustable Lace Attaching Foot

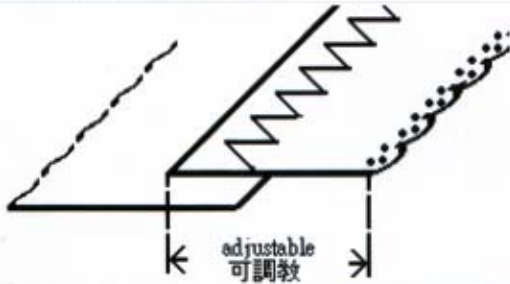

### 107-029K

人字開式縫可調教花邊面貼壓腳  
Zigzag Open Seam Adjustable Lace Attaching Foot



### 23770

人字面貼壓腳  
Zigzag Tape Attaching Foot

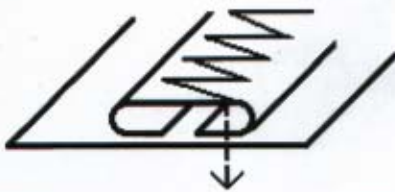

### 23770K

人字開式縫面貼壓腳  
Zigzag Open Seam Tape Attaching Foot

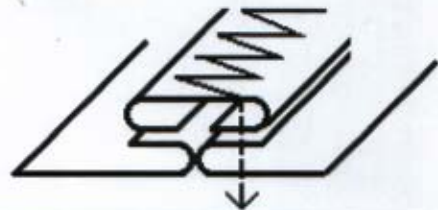
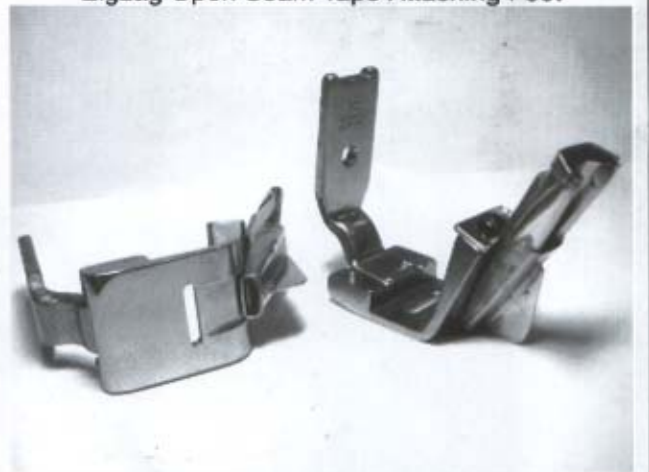

**210562A-3**



壓腳寬度 Presser Foot Width: 14.5mm

**210516A-3 210596A-3**

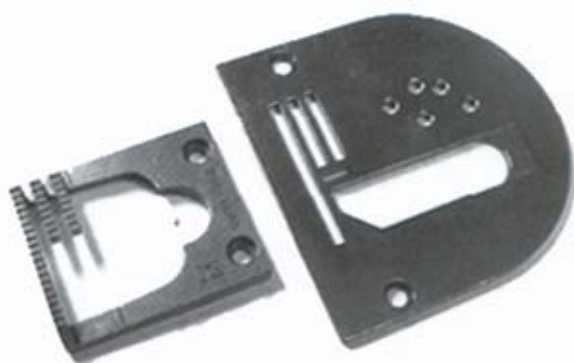

齒面寬度 Teeth Width: 10mm

**210562A-4**



壓腳寬度 Presser Foot Width: 16mm

**210516A-4 210596A-4**



齒面寬度 Teeth Width: 14mm

**210562A-5**



壓腳寬度 Presser Foot Width: 18mm

**210516A-5 210596A-5**

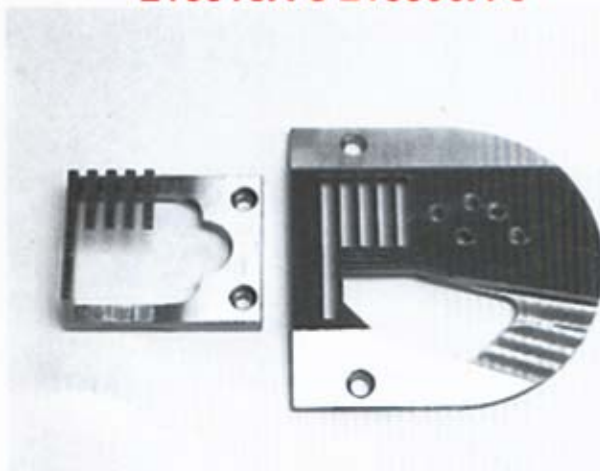

特厚針板 Extra-thick Needle Plate  
齒面寬度 Teeth Width: 17.5



457-CL



人字左傍壓腳

Zigzag Presser Foot with Left Compensating Guide

210562A-2



壓腳寬度 Presser Foot Width: 12mm

210569-A

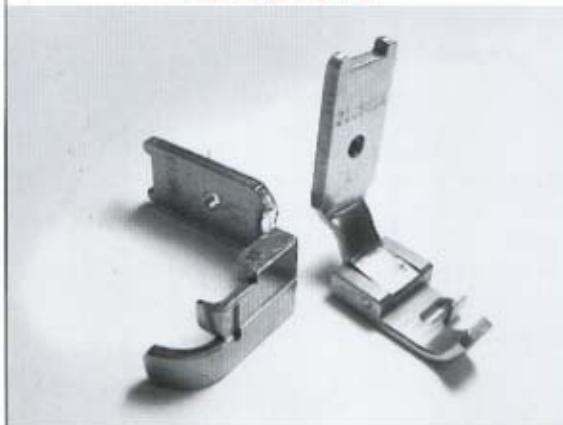

壓腳寬度 Presser Foot Width: 13mm

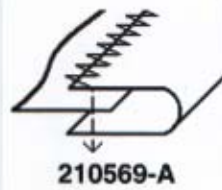

210569-B



壓腳寬度 Presser Foot Width: 10.5mm

212-005A



可調教網條尺寸 Adjustable Tape Size

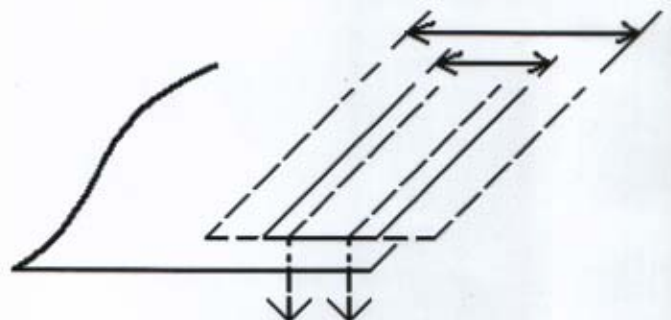

- 1, 針距 Needle Space: 3.2mm  
網條尺寸 Tape Size: 5.5mm ~ 22mm
- 2, 針距 Needle Space: 4.8mm  
網條尺寸 Tape Size: 6.5mm ~ 22mm
- 3, 針距 Needle Space: 6.4mm  
網條尺寸 Tape Size: 7.8mm ~ 22mm



**212-112**



可調教細條尺寸 Adjustable Tape Size

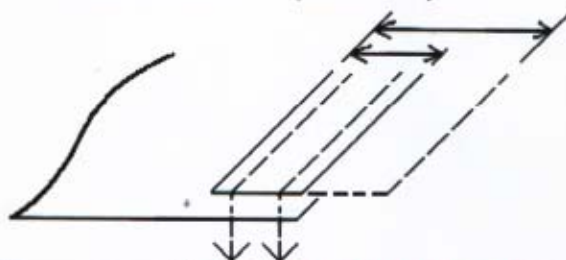

- 1, 針距 Needle Space: 4.8mm  
細條尺寸 Tape Size: 6.5mm ~ 11.2mm
- 2, 針距 Needle Space: 6.4mm  
細條尺寸 Tape Size: 8mm ~ 16.6mm

**212-684**

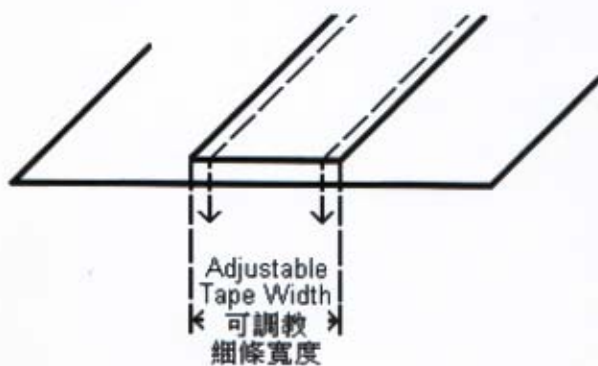

**23061**

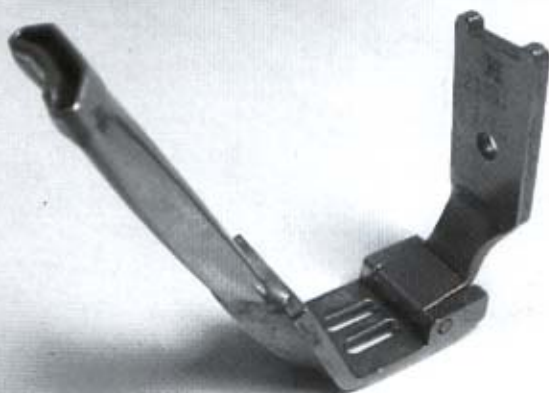

面貼細條 Tape Attaching

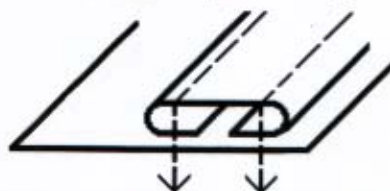

針距 Needle Space	入口 Tape Size	出口 Finished Size
3/16"	5/8"	5/16"
3/16"	3/4"	5/16" 搭口 Overlapped
1/4"	3/4"	3/8"
1/4"	7/8"	3/8" 搭口 Overlapped

**23071**

開式縫面貼網條壓腳 Open Seam Tape Attaching Feet

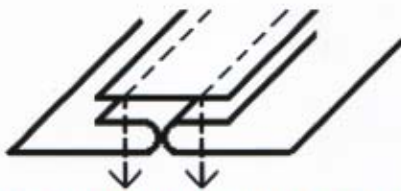

針距 Needle Space: 1/8", 3/16", 1/4"

**23072**

調節式面貼網條壓腳 Adjustable Tape Attaching Feet

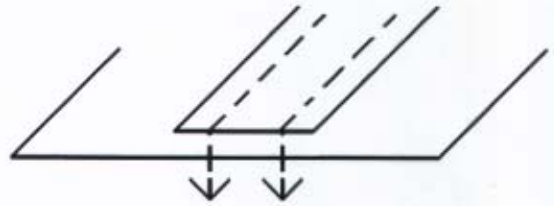

針距 Needle Space: 1/4"

可調節入口尺寸 Adjustable Tape Size: 8.5mm-16mm

**23073**

開式縫面貼網條壓腳

Open Seam Tape Attaching Foot

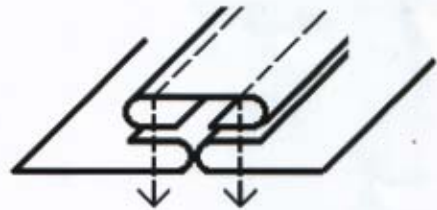

針距 Needle Space	入口 Tape Size	出口 Finished Size
3/16"	5/8"	5/16"
1/4"	3/4"	3/8"

**23207** 開式縫面貼網條壓腳 **Open Seam Tape Attaching Foot**

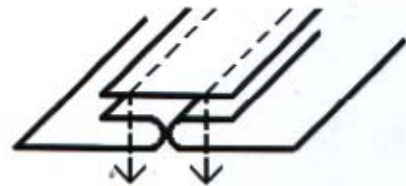

針距 Needle Space: 1/8", 3/16", 1/4"

可用配備 Applicable Attachment: 24711

**24711** 懸掛式面貼器 **Suspended Tape Folder**

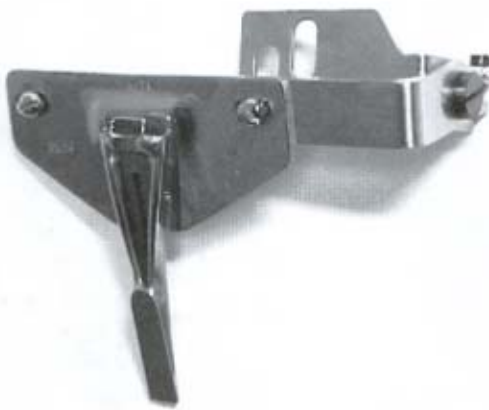

針距 Needle Space	入口 Tape Size
3.2mm	15mm
4.8mm	18mm
6.4mm	23mm



24711

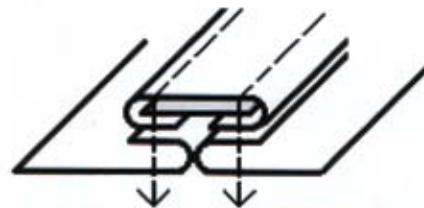

24711 + 23207

**21140** 胸圍鋼圈導帶器 **Strip Guide with Cover Plate**

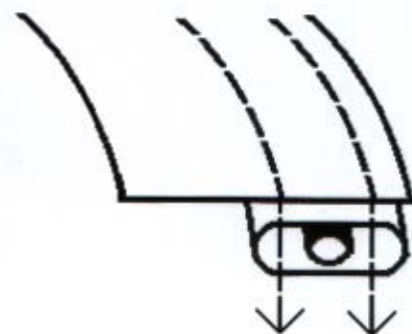

帶子寬度 Strip Size: 9mm, 10mm, 12mm



**21139** 胸罩用導帶器 Strip Guide for Brassieres

**21139A**



**21139B**

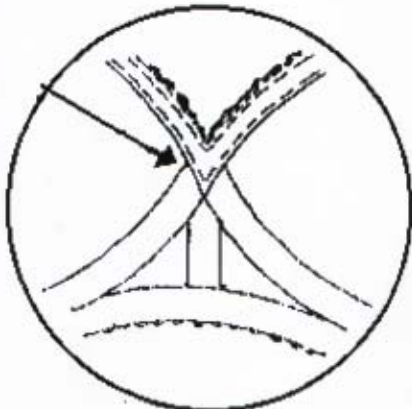

21139A



21139A 或 21139B 配合  
K41B 推板及 KHF71 一起使用  
Fit 21139A or 21139B to  
K41B Slide Plate and KHF71 Folder



21139B  
21139C

**21139C**



胸罩用導帶器 Strip Guide for Brassieres

**K41B**



雙針推板 Double Needle Slide Plate

**雙針針位 2N Gauge Set**



**PR112 PL112**



**PD112**



**雙針針位  
2 Needle  
Gauge Set**

Size: 1/16", 3/32", 1/8", 5/32", 3/16", 7/32", 1/4", 9/32", 5/16", 11/32", 3/8", 12/32", 7/16", 1/2", 9/16", 5/8", 11/16", 3/4", 13/16", 7/8", 15/16", 1", 1-1/16", 1-1/8", 1-3/16", 1-1/4", 1-5/16", 1-3/8", 1-7/16", 1-1/2", 1-5/8", 1-3/4", 1-7/8"

**PR112  
PL112**

PR112x1 (right guide for light duty 右傍薄料用)  
PR112x1.8 (right guide for heavy duty 右傍厚料用)  
PL112x1 (left guide for light duty 左傍薄料用)  
PL112x1.8 (left guide for heavy duty 左傍厚料用)

**針距 Needle Space**

1/8"	3/16"	1/4"
5/16"	3/8"	1/2"

**PD112**

PD112x1 (double guide for light duty 雙傍薄料用)  
PD112x1.8 (double guide for heavy duty 雙傍厚料用)

**針距 Needle Space**

1/4"	3/8"	1/2"
5/8"	3/4"	7/8"
1"	1-1/8"	1-1/4"
1-3/8"	1-1/2"	

**PH112W**



**112WC9**



**112W-Z**



**PH112W**

Double Needle Piping Feet 雙針繩仔壓腳  
Size: 1/4", 1/2"

**112WC9**

Double Needle Dual Compensating Feet 雙針鞦韆高低壓腳  
Size: 3/4", 7/8", 1", 1-1/8", 1-1/4", 1-3/8", 1-1/2"  
Guide Can be adjusted. 傍位可以自由調教

**112W-Z**

Double Needle Zipper Feet 雙針拉鍊壓腳  
Size: 1/8", 3/16", 1/4"

**112W952**

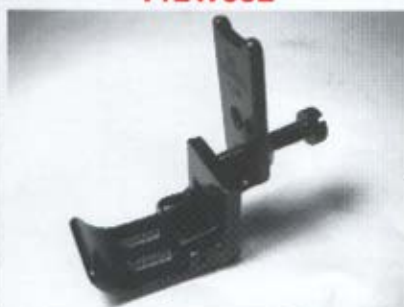

Double Needle Shirring Feet  
雙針縮摺壓腳

**尺寸 Size**

3/16"	1/4"
-------	------

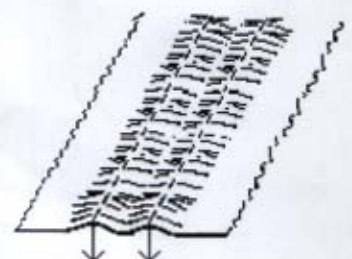



	<p><b>21010</b></p> 	<p><b>K22060S</b></p> 	<p><b>K224060M</b></p> 
<p><b>21010</b></p>	<p>Gauge Set for Brassiere Tape Attaching Folder 雙針胸罩貼邊器用針位                  21010-1 Presser foot with right compensating guide 右傍壓腳                  21010-2 Needle Plate 針板                  21010-3 Feed Dog 送布齒                  Size: 1/8", 3/16", 7/32", 1/4"</p>		
<p><b>K224060S</b></p>	<p>Adjustable Double Needle Piping Feet 可調教式雙針管條壓腳                  Needle Space Adjustable between 3/8" &amp; 7/8" 針距可在 3/8" 和 7/8" 之間隨意調教</p>		
<p><b>K224060M</b></p>	<p>Adjustable Double Needle Zipper Feet 可調教式雙針左右兩用拉鍊壓腳                  Needle Space Adjustable between 7/16" &amp; 1" 針距可在 7/16" 和 1" 之間隨意調教</p>		





**23067**  
 胸圍用雙針包縫針位  
 Double Needle Gauge Set for Bra Binding

112607SP 推板 Slide Plate  
 23067NP 針板 Needle Plate  
 23067FD 送布齒 Feed Dog  
 23067PF 壓腳 Presser Feet

Needle Size 針距	Tape Size 入口	Finished Size 出口
3/16"	1-1/4"	5/16"
1/4"	1-1/2"	3/8"

可配合 KHF36 使用 Applicable with KHF36

<p><b>Cylinder-bed binding</b></p> 	<p><b>S512S &amp; S513S</b></p> 	<p><b>U192B &amp; U193B</b></p> 
<p>筒型車包邊壓腳 Cylinder-bed Machine Binding Presser Feet                  百福 PFAFF 44227 &amp; 42819                  祖奇 JUKI MAQ980A0 &amp; MAQ10452000                  精工 SEIKO 17086 &amp; 17083</p>		
<p><b>S512S S513S</b></p>	<p>筒型車包邊壓腳 Cylinder-bed Machine Binding Presser Feet</p>	
<p><b>U192B U193B</b></p>	<p>單針上下送布壓腳 Single Needle, Upper and Lower Feeding Machine Presser Feet</p>	



平車高低針板、牙  
Special Needle Plate & Feed Dog for Folders



	針板 Needle Plate	牙 Feed Dog
3 排牙 3 Rolls	<b>NP-3</b>	<b>FD-3</b>
4 排牙 4 Rolls	<b>NP-4</b>	<b>FD-4</b>
5 排牙 5 Rolls	<b>NP-5</b>	<b>FD-5</b>
6 排牙 Rolls	<b>NP-6</b>	<b>FD-6</b>

**KH5**

平車五行針板牙(針孔在中央)  
5 Rolls Needle Plate and Feed Dog (Hole in Central)

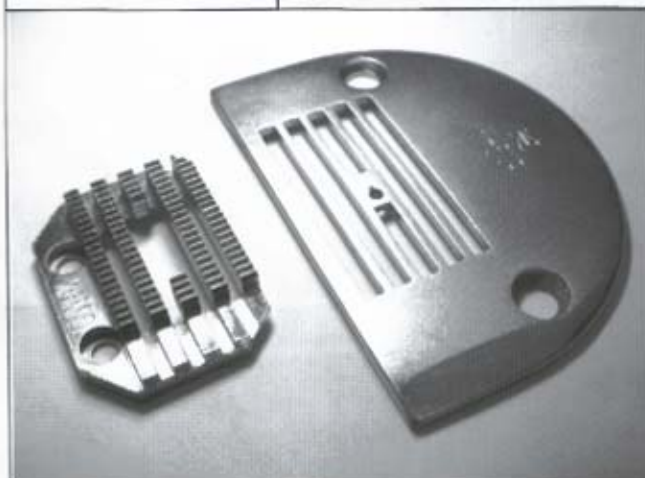

**KH5-NP** 針板 Needle Plate  
**KH5-FP** 牙 Feed Dog

可用助縫器 Applicable Folder:  
KHF101, KHF102, KHF9, KHF17, KHF24 ...

**KH7**

平車七行針板牙  
7 Rolls Needle Plate and Feed Dog

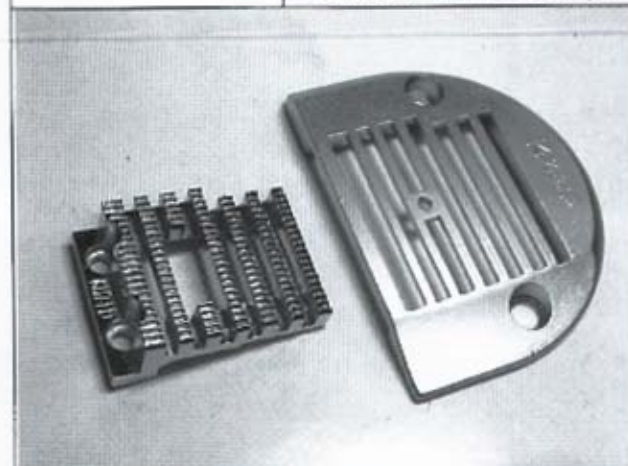

剪線平車或普通平車同樣合用  
Suitable for Single Machine with or without  
Automatic Thread Trimmer

**KH7-NP** 針板 Needle Plate  
**KH7-FP** 牙 Feed Dog

	KR-10	A10	K10
			
KR-10	Feet for A10 Binder (Hinged) A10 包縫器用壓腳 (活動) A10 Finished Size 網條出口尺寸: 3/16, 1/4, 5/16, 3/8, 1/2		
A10	Feet for A10 Binder (Solid) A10 包縫器用壓腳 (固定) A10 Tape Size 網條入口尺寸: 5/8, 3/4, 7/8, 1, 1-1/8, 1-1/4, 1-1/2		
K10	Feet for K10 Binder (Solid) K10 包縫器用壓腳 (固定) K10 Tape Size 網條入口尺寸: 22mm, 26mm, 32mm, 40mm		

	KB	131S (12142S)	KR-1
			
KB	Compensating Feet for A10 Binder A10 直角包縫器用高低壓腳 A10 Tape Size 網條入口尺寸: 3/4, 1", 1-1/4		
131S (12142S)	Solid Binding Feet 包縫器用壓腳 (固定)		
KR-1	Right Compensating Feet for Folder 右高低摺邊器用壓腳 Size: 1/32, 1/16		

	KL-1	KL-11	KL-13
			
KL-1	Left Compensating Feet For Folder 左高低摺邊器用壓腳 Size: 1/32, 1/16		
KL-11	Central Compensating Feet For Folder 中間高低摺邊器用壓腳 Size: 3/4, 7/8, 1", 1-1/4"		
KL-13	Hemming Feet 摺邊壓腳 Size: 3/8, 1/2, 5/8, 3/4, 7/8, 1", 1-1/8, 1-1/4, 1-1/2		



CKL-13		P3610 ~ P3625		P3811 ~ P3825			
<b>CKL-13</b>	Left Compensating Feet For Folder (Wide) 左高低摺邊器用壓腳(闊) Size : 15mm , 25mm						
<b>P3610 ~ P3625</b>	Hemming Feet 摺邊壓腳						
	P3610	P3611	P3613	P3615	P3619	P3620	P3625
	5mm	6mm	8mm	10mm	14mm	15mm	20mm
<b>P3811 ~ P3825</b>	Edge Guide Hemming Feet 傍邊摺邊壓腳						
	P3811	P3813	P3815	P3819	P3822	P3825	
	6mm	8mm	10mm	14mm	17mm	20mm	

SP-19		SP-705		SP-733	
<b>SP-19</b>	Hemming Feet with Edge Guide 傍邊摺邊壓腳 Size: 3/8				
<b>SP-705</b>	Left Compensating Feet for Folder 摺邊器用左高低壓腳 Size : 1/32, 1/16				
<b>SP-733</b>	Hemming Feet with Edge Guide 傍邊摺邊壓腳 Size : 1/8, 3/16, 1/4, 5/16, 3/8, 1/2				

SP-98		SP-102	
<b>SP-98</b>	Feet for KHF98 Tucking Attachment KHF98 打摺器用壓腳 Size: 1/8, 3/16		
<b>SP-102</b>	Feet for KHF102 Sleeves Attachment KHF102 接袖器用壓腳 Size between Guide and Needle Hole 針孔與傍位的間距 : 3/16, 1/4, 5/16, 3/8.		





Scroll Hemmer Feet 渦型捲邊壓腳		
160344H	1/16	
120803H	1/8	
120805H	3/16	
120806H	1/4	



490357	Hemmer Feet (Single Fold Upturn) 捲邊壓腳(單捲上摺) Size: 3/16, 1/4
490358	Ball Hemmer Feet (Double Fold Upturn) 球型壓腳(雙捲上摺) Size: 1/16, 1/8, 3/16, 1/4
490359	Spring Hemmer Feet (Double Fold Upturn) 彈弓捲邊壓腳(雙捲上摺) Spring allows cross seams to pass through freely Size: 1/16, 1/8, 3/16, 1/4
490360	Wire Hemmer Feet (Double Fold Upturn) 鋼線捲邊壓腳(雙捲上摺) Size: 1/16, 1/8, 3/16, 1/4

P69R	P69L	P69D
		
P69R	P69L	P69D
Solid Piping Feet (Right) 繩管固定壓腳(右) Size: 3/8, 1/2	Solid Piping Feet (Left) 繩管固定壓腳(左) Size: 3/8, 1/2	Solid Double Grooved Piping Feet 繩管固定雙坑壓腳 Size: 1/8, 3/16, 1/4

## 關西多針車針位 Multi-needle Gauge Set for Kansai Special

Model No.	針數 Needle	針距分配 Needle Space Distribution (ns = 針距數目 Amount of needle space )	
<b>1404P</b>			
1/4 x 4N	4	1/4" x 3ns = 3/4"	
7/16 x 4N	4	7/16" x 3ns = 1-5/16"	
1/2 x 4N	4	1/2" x 3ns = 1-1/2"	
5/8 x 4N	4	5/8" x 3ns = 1-7/8"	
1 (4N)	4	平均分配於 1"之間 Even Distributed within 1"	
1-1/8 (4N)	4	平均分配於 1-1/8"之間 Even Distributed within 1-1/8"	
1-1/4 (4N)	4	平均分配於 1-1/4"之間 Even Distributed within 1-1/4"	
1-3/8 (4N)	4	平均分配於 1-3/8"之間 Even Distributed within 1-3/8"	
<b>1404PSF</b>			
1/4 + 1/2 + 1/4	4	1/4" + 1/2" + 1/4" = 1"	
1/4 + 5/8 + 1/4	4	1/4" + 5/8" + 1/4" = 1-1/8"	
1/4 + 3/4 + 1/4	4	1/4" + 3/4" + 1/4" = 1-1/4"	
1/4 + 7/8 + 1/4	4	1/4" + 7/8" + 1/4" = 1-3/8"	
1/4 + 1 + 1/4	4	1/4" + 1" + 1/4" = 1-1/2"	
1/4 + 1-1/8 + 1/4	4	1/4" + 1-1/8" + 1/4" = 1-5/8"	
1/4 + 1/4 + 1 + 1/4	5	1/4" + 1/4" + 1" + 1/4" = 1-3/4"	
3/16 + 5/8 + 3/16	4	3/16" + 5/8" + 3/16" = 1"	
3/16 + 3/4 + 3/16	4	3/16" + 3/4" + 3/16" = 1-1/8"	
3/16 + 7/8 + 3/16	4	3/16" + 7/8" + 3/16" = 1-1/4"	
3/16 + 1 + 3/16	4	3/16" + 1" + 3/16" = 1-3/8"	
3/16 + 1-1/8 + 3/16	4	3/16" + 1-1/8" + 3/16" = 1-1/2"	
<b>1404PL</b>			
1/2 x 3N	3	1/2" x 2ns = 1"	
1/2 x 5N	5	1/2" x 4ns = 2"	
3/16 x 6N	6	3/16" x 5ns = 15/16"	
1/4 x 6N	6	1/4" x 5ns = 1-1/4"	
5/16 x 6N	6	5/16" x 5ns = 1-9/16"	
3/8 x 6N	6	3/8" x 5ns = 1-7/8"	
7/16 x 6N	6	7/16" x 5ns = 2-3/16"	
3/16 x 8N	8	3/16" x 7ns = 1-5/16"	
1/4 x 8N	8	1/4" x 7ns = 1-3/4"	
5/16 x 8N	8	5/16" x 7ns = 2-3/16"	
3/16 x 10N	10	3/16" x 9ns = 1-11/16"	
1/4 x 10N	10	1/4" x 9ns = 2-1/4"	
1/8 x 11N	11	(1/8" x 4ns) + (1/4" x 2ns) + (1/8" x 4ns) = 1-1/2"	
3/16 x 12N	12	3/16" x 11ns = 2-1/16"	
1/8 x 13N	13	(1/8" x 5ns) + (1/4" x 2ns) + (1/8" x 5ns) = 1-3/4"	
1/8 x 17N	17	1/8" x 16ns = 2"	



Model No.	針數 Needle	針距分配 Needle Space Distribution (ns = 針距數目 Amount of needle space )
<b>1406~1412 P,PL</b>		
3/16 x 6N	6	3/16" x 5ns = 15/16"
1/4 x 6N	6	1/4" x 5ns = 1-1/4"
5/16 x 6N	6	5/16" x 5ns = 1-9/16"
3/8 x 6N	6	3/8" x 5ns = 1-7/8"
7/16 x 6N	6	7/16" x 5ns = 2-3/16"
3/16 x 8N	8	3/16" x 7ns = 1-5/16"
1/4 x 8N	8	1/4" x 7ns = 1-3/4"
5/16 x 8N	8	5/16" x 7ns = 2-3/16"
3/8 x 8N	8	3/8" x 7ns = 2-5/8"
7/16 x 8N	8	7/16" x 7ns = 3-1/16"
3/16 x 10N	10	3/16" x 9ns = 1-11/16"
1/4 x 10N	10	1/4" x 9ns = 2-1/4"
3/16 x 12N	12	3/16" x 11ns = 2-1/16"
1/4 x 12N	12	1/4" x 11ns = 2-3/4"
2-1/4 (13N)	13	1/4" + (1/8" x 2) + (1/4" x 2) + (1/8" x 2) + (1/4" x 2) + (1/8" x 2) + 1/4" = 2-1/4"
1/8 x 17N	17	1/8 x 16N = 2"
1/8 x 23N	23	1/8 x 22N = 2-3/4"
<b>1508P</b>		
1/4 + 3/4 + 1/4	4	1/4" + 3/4" + 1/4" = 1-1/4"
1/4 + 13/16 + 1/4	4	1/4" + 13/16" + 1/4" = 1-5/16"
1/4 + 7/8 + 1/4	4	1/4" + 7/8" + 1/4" = 1-3/8"
1/4 + 1 + 1/4	4	1/4" + 1" + 1/4" = 1-1/2"
1/4 + 1-1/8 + 1/4	4	1/4" + 1-1/8" + 1/4" = 1-5/8"
1/4 + 1-1/4 + 1/4	4	1/4" + 1-1/4" + 1/4" = 1-3/4"
1/4 + 1-1/2 + 1/4	4	1/4" + 1-1/2" + 1/4" = 2"

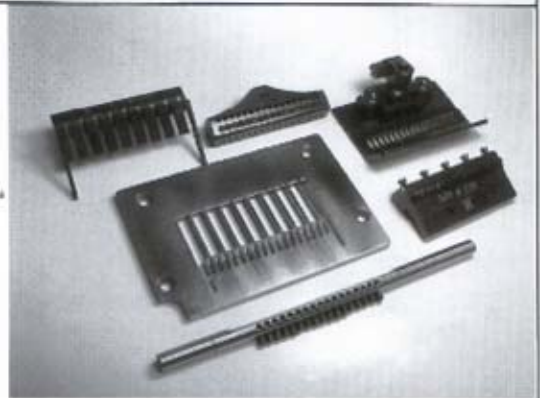

# KP404G

## 關西 1404PSF 襯衫前胸筒傍位壓腳 Shirt Front Guiding Presser Feet for 1404PSF

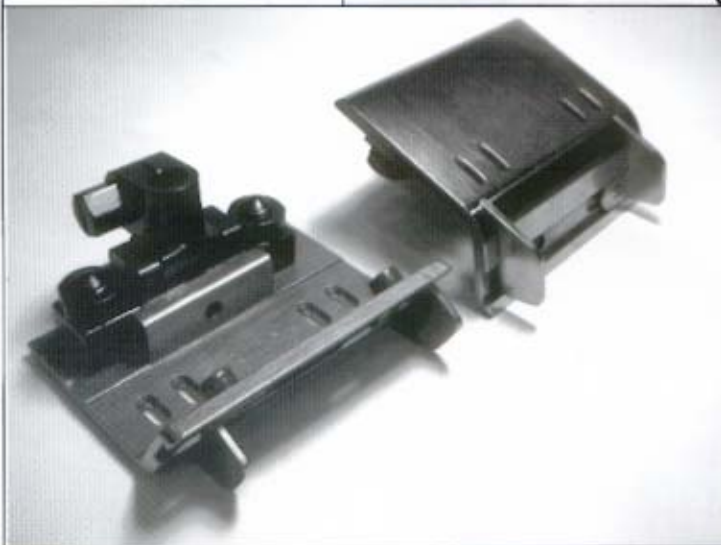

針距寬度 Needle Space
1/4" + 1/2" + 1/4"
1/4" + 5/8" + 1/4"
1/4" + 3/4" + 1/4"
1/4" + 7/8" + 1/4"
1/4" + 1" + 1/4"
1/4" + 1-1/8" + 1/4"
3/16" + 5/8" + 3/16"
3/16" + 3/4" + 3/16"
3/16" + 7/8" + 3/16"
3/16" + 1" + 3/16"
3/16" + 1-1/8" + 1/4"

可調教傍位寬度 Adjustable Guide Width





<b>17-7620-1</b>	1702 皮帶環縫製壓腳 Presser Feet for 1702 Belt Loop Machine 針距 Needle Space : 1/4" 傍位 Guide : 可調教 Adjustable
<b>KH577</b>	1702 多針距皮帶環縫製壓腳 Multi-size Presser Feet for 1702 Belt Loop Machine 針距 Needle Space : 1/8" ~ 1/4" 傍位 Guide : 可調教 Adjustable
<b>D530</b>	豐田人字包縫針板、牙 TOYOTA Zigzag Needle Plate & Feed Dog for Binder D530-40F 針板 Needle Plate D530-171F 送布齒 Feed Dog

**112607SP** 推板 Slide Plate  
**240144B** 針板 Needle Plate  
**240112HB** 送布齒 Feed Dog

中厚物單針縫針位 1 Needle Gauge Set for medium to heavy materials

e.g. 精工 SEIKO LSW-8BL, 祖奇 JUKI LU2-562/563,  
三菱 MITSUBISHI LU2-4420

**524-206-4L** 針板 Needle Plate  
**524-206-3** 送布齒 Feed Dog

中厚物單針上下送布針位  
Gauge Set for medium to heavy materials

e.g. 精工 SEIKO LSW-8BL, 祖奇 JUKI LU2-562/563,  
三菱 MITSUBISHI LU2-4420

# 網條架 Tape Rack

**TS-2**

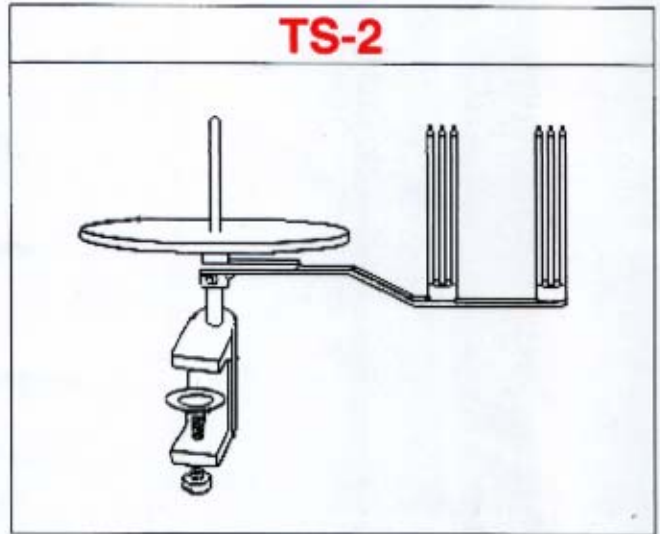

**TS-1**

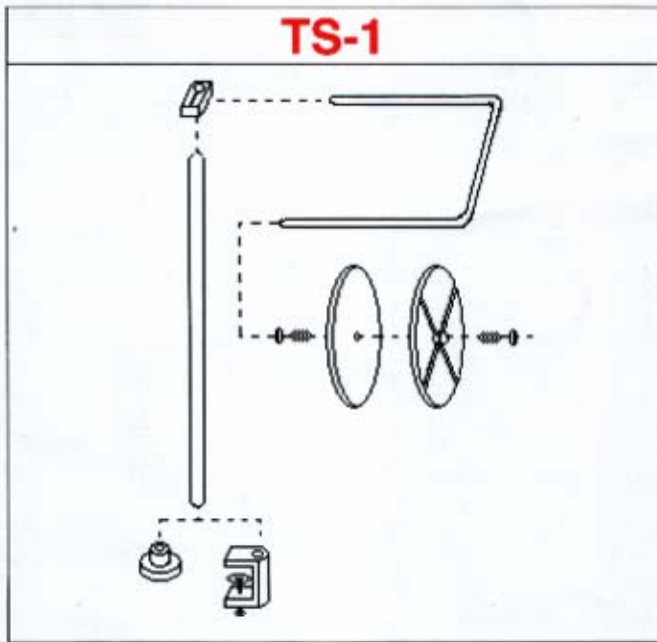

**TS-3**

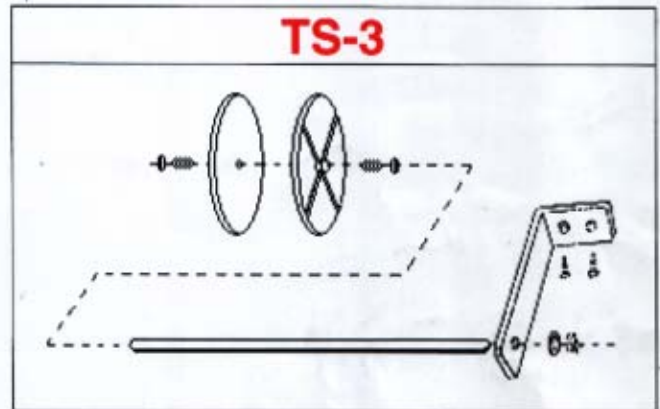

**ES-1**

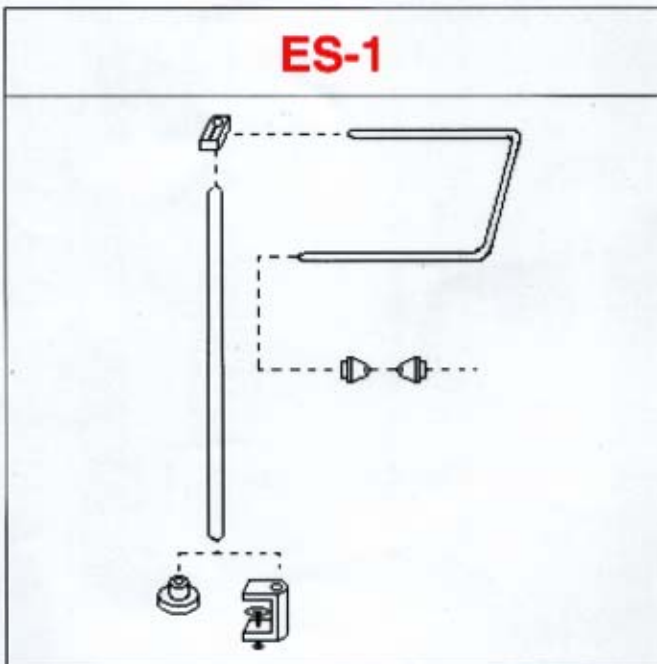

**ES-2**

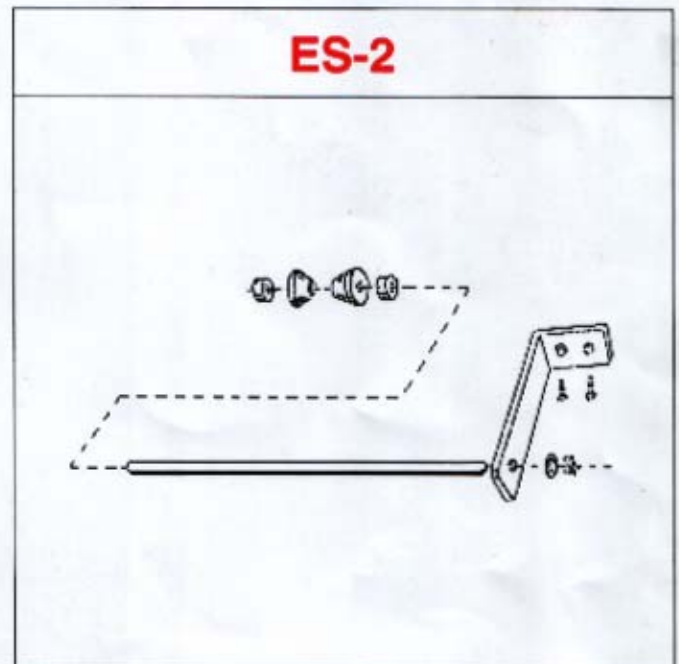



### 細條架 Tape Rack

**KTR-3**

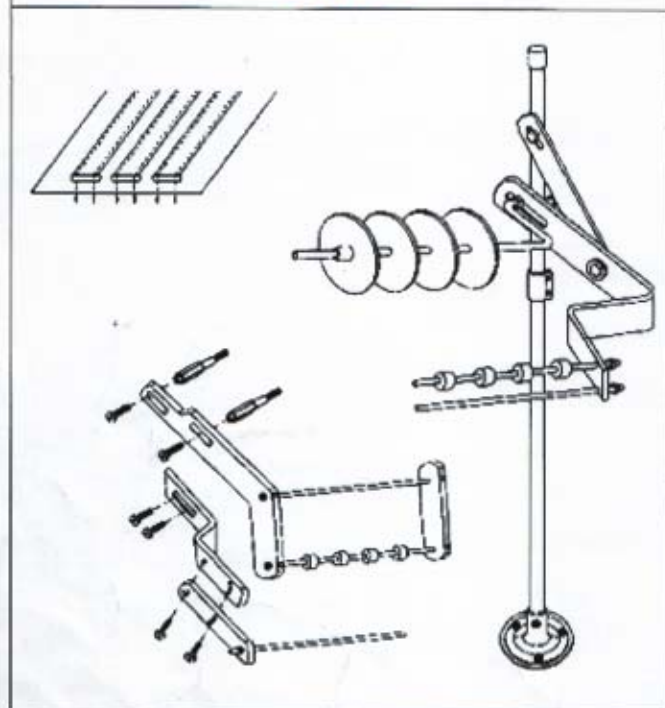

**KTR-4**

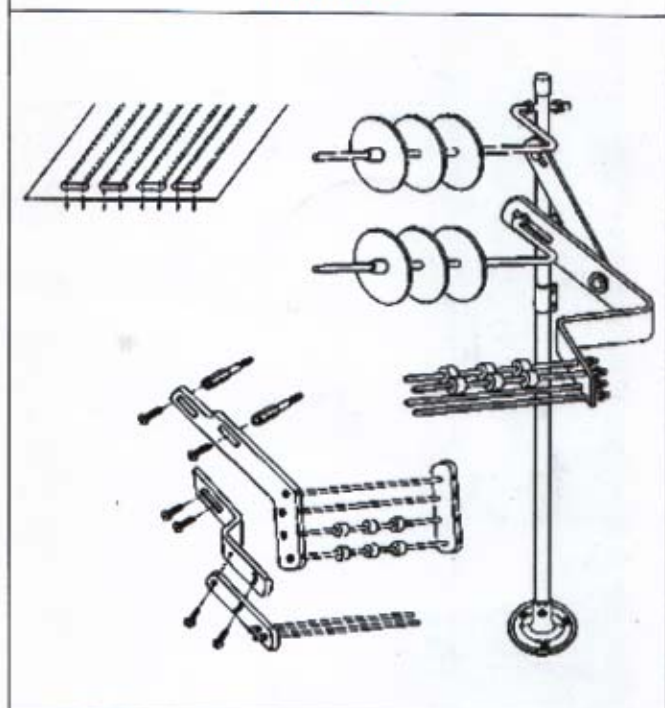

**KTR-5**

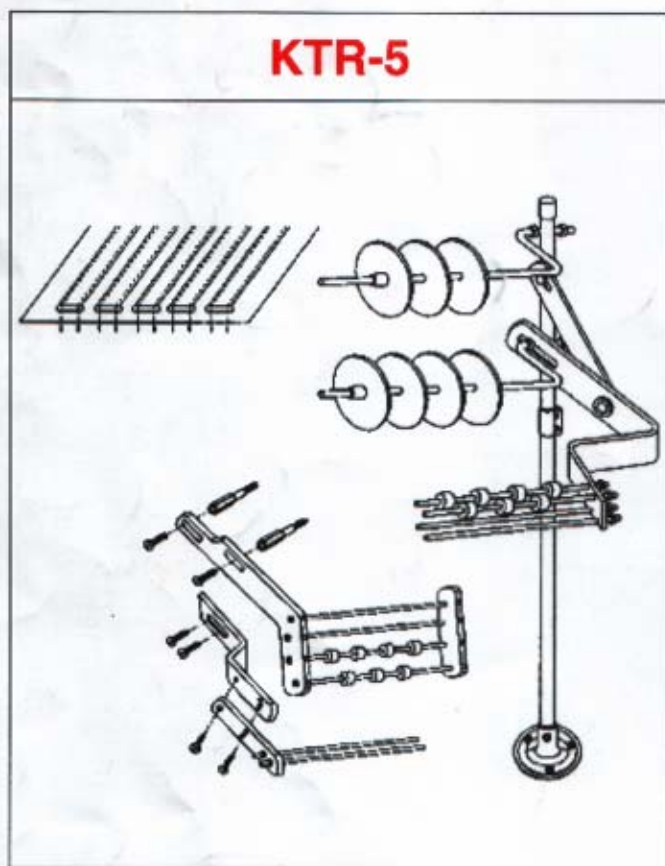

**KTR-6**

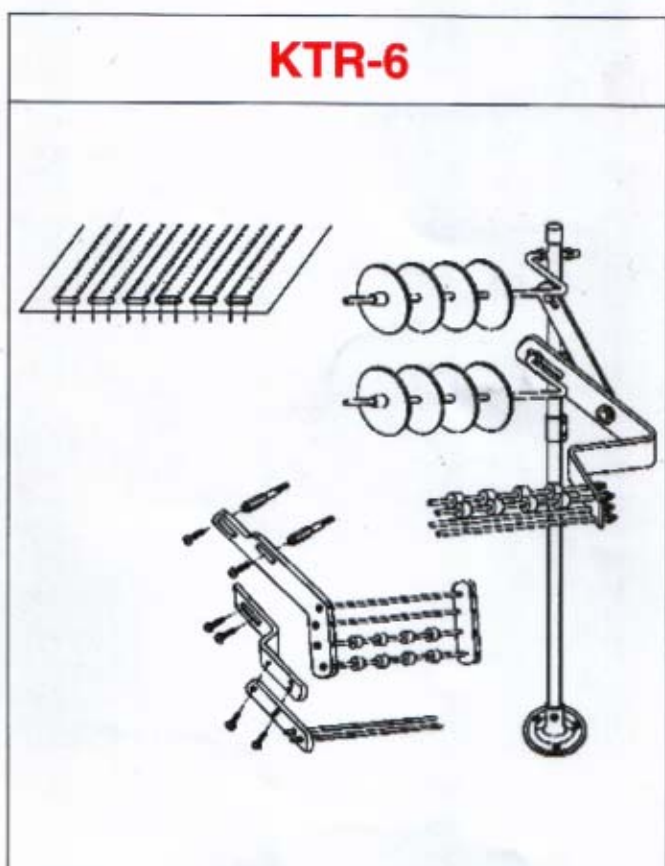

**KHM-803****側送型送料器**  
**Lateral Feeder**

多用於包縫工作，置於縫紉機的右側，把網條送至包縫器。

It is mainly used for binding, mounted on the table at the right hand side of sewing machine and feed tape into the binder.

**KHM-803A****光學側送型送料器**  
**Optical Lateral Feeder**

多用於包縫工作，置於縫紉機的右側，把網條送至包縫器。光學感應器比一般感應器更敏感，但不適用於透明物料。

It is mainly used for binding, mounted on the table at the right hand side of sewing machine and feed tape into the binder. Optical detector is more sensitive than the normal one. But it is not suitable for transparent material.

**KHM-804****垂直型送料器**  
**Downward Feeder**

多用於面貼或鬆緊帶，置於縫紉機後，由上而下把網條或鬆緊帶送至機前。

It is mainly used for tape or elastic sewing, mounted behind the sewing machine and feed material into the machine.

**KHM-804A****光學垂直型送料器**  
**Optical Downward Feed**

多用於包縫工作，置於縫紉機的右側，把網條送至包縫器。光學感應器比一般感應器更敏感，但不適用於透明物料。

It is mainly used for binding, mounted on the table at the right hand side of sewing machine and feed tape into the binder. Optical detector is more sensitive than the normal one. But it is not suitable for transparent material.



往深水埗 To Shum Siu Po



往旺角 To Mongkok

地鐵路綫圖 MTR System Map

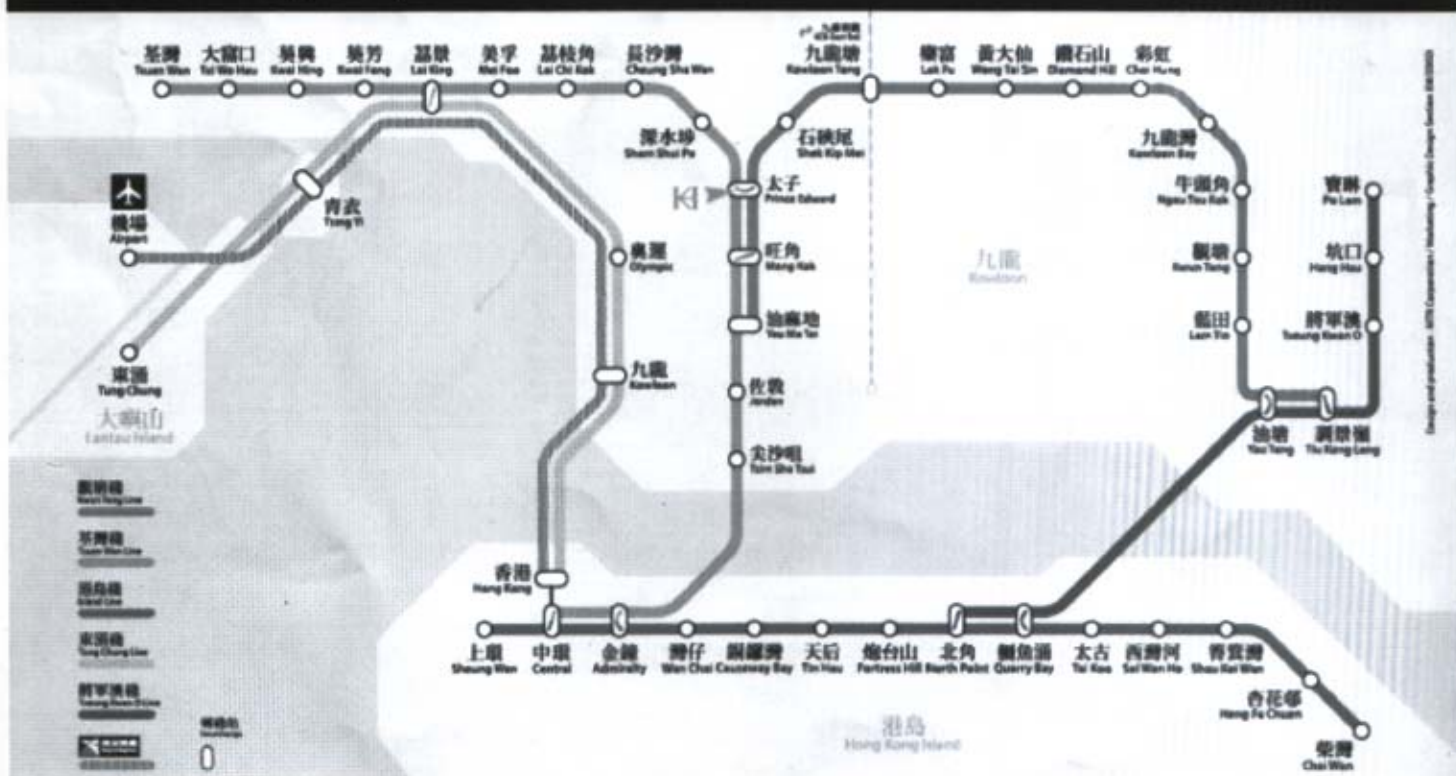



**國興針車公司 Kwok Hing Sewing Machine Co.**

香港九龍荔枝角道 103-107 號地下

G/F., 103-107 Lai Chi Kok Road, Kowloon, Hong Kong

Tel: (852) 23948163-6 Fax: (852) 27892681

Website: <http://www.kwokhing.com> Email: [marketing@kwokhing.com](mailto:marketing@kwokhing.com)



必先利其器

工欲善其事

KHF

2004

K

www.kwaking.com